



THE
RCFT ORIENTIFOLD
“LANDSCHAP”

BASED ON WORK WITH:

- Huiszoon, Fuchs, Schweigert and Walcher [Formalism]
Phys.Lett.B495:427-434,2000
- Huiszoon, Dijkstra [SM Search]
Phys.Lett.B609:408-417,2005, Nucl.Phys.B710:3-57,2005
- Anastasopoulos, Dijkstra, Kiritsis [SM Search]
Nucl.Phys.B759:83-146,2006
- Ibañez, Uranga [Majorana masses from instantons]
(arXiv:0704.1079, JHEP, to appear)
- Gato-Rivera [Non-supersymmetric strings]
(arXiv:0709.1426, Phys. Lett. B, to appear)

STRING THEORY

A *candidate* theory of quantum gravity.

Candidate: we only know some promising perturbative expansions, not the theory itself. We do not even know for sure if it exists!

There are reasons to believe that any theory of quantum gravity must include all other matter and interactions as well.

EARLY INSIGHT (~ 1982)...

Soon after starting graduate school, I went to see Howard Georgi. “What are you thinking about?” he asked me. I rattled off several things that seemed interesting to me, ending with, “... and quantum gravity.” “**Don’t waste your time!**” he barked, “There’s no decoupling limit in which it’s sensible to consider quantum gravity effects, while neglecting other interactions. Unless you know particle physics all the way up to the Planck scale, you can never hope to say anything predictive about quantum gravity.” Howard was, of course, completely correct.

Jacques Distler, “Musings”

EARLY INSIGHT (~ 1982)...

Soon after starting graduate school, I went to see Howard Georgi. “What are you thinking about?” he asked me. I rattled off several things that seemed interesting to me, ending with, “... and quantum gravity.” “**Don’t waste your time!**” he barked, “There’s no decoupling limit in which it’s sensible to consider quantum gravity effects, while neglecting other interactions. Unless you know particle physics all the way up to the Planck scale, you can never hope to say anything predictive about quantum gravity.” Howard was, of course, completely correct.

Jacques Distler, “Musings”

MATTER

String Theory addresses this by already having all matter (and all interactions) built in from the start.

Therefore it must include the Standard Model, Dark Matter and anything that might exist beyond the SM.

PREDICTIONS?

PREDICTIONS?

This does not imply that it must make any low energy predictions.

If it does, we are just lucky.

If it does not, we are at worst in the same situation one should have expected for a theory of quantum gravity: one can only check it by means of consistency conditions.

PREDICTIONS?

This does not imply that it must make any low energy predictions.

If it does, we are just lucky.

If it does not, we are at worst in the same situation one should have expected for a theory of quantum gravity: one can only check it by means of consistency conditions.

**In fact, we are in a much better situation:
we have a Landscape!**

The “Landscape”

Lerche, Lüst, Schellekens

“Chiral, Four-dimensional Heterotic Strings From Self-Dual Lattices”, 1986

this number is of order 10^{1500} !

Even if all that string theory could achieve would be a completely finite theory of all interactions including gravity, but with no further restrictions on the gauge groups and the representations, it would be a considerable success.

Douglas, DeNef (2004):

10^{500} vacua

The image shows the front cover of a book. The cover is a solid, bright orange color. In the center, there is a white rectangular border. Inside this border, the title 'Naar een waardig slot' is printed in a dark, serif font. Below the title, the author's name 'Bert Schellekens' is printed in a smaller, italicized serif font. The book is shown at a slight angle, with the spine visible on the left side.

Naar een waardig slot

Bert Schellekens

Dutch version
(1998)

physics/0604134

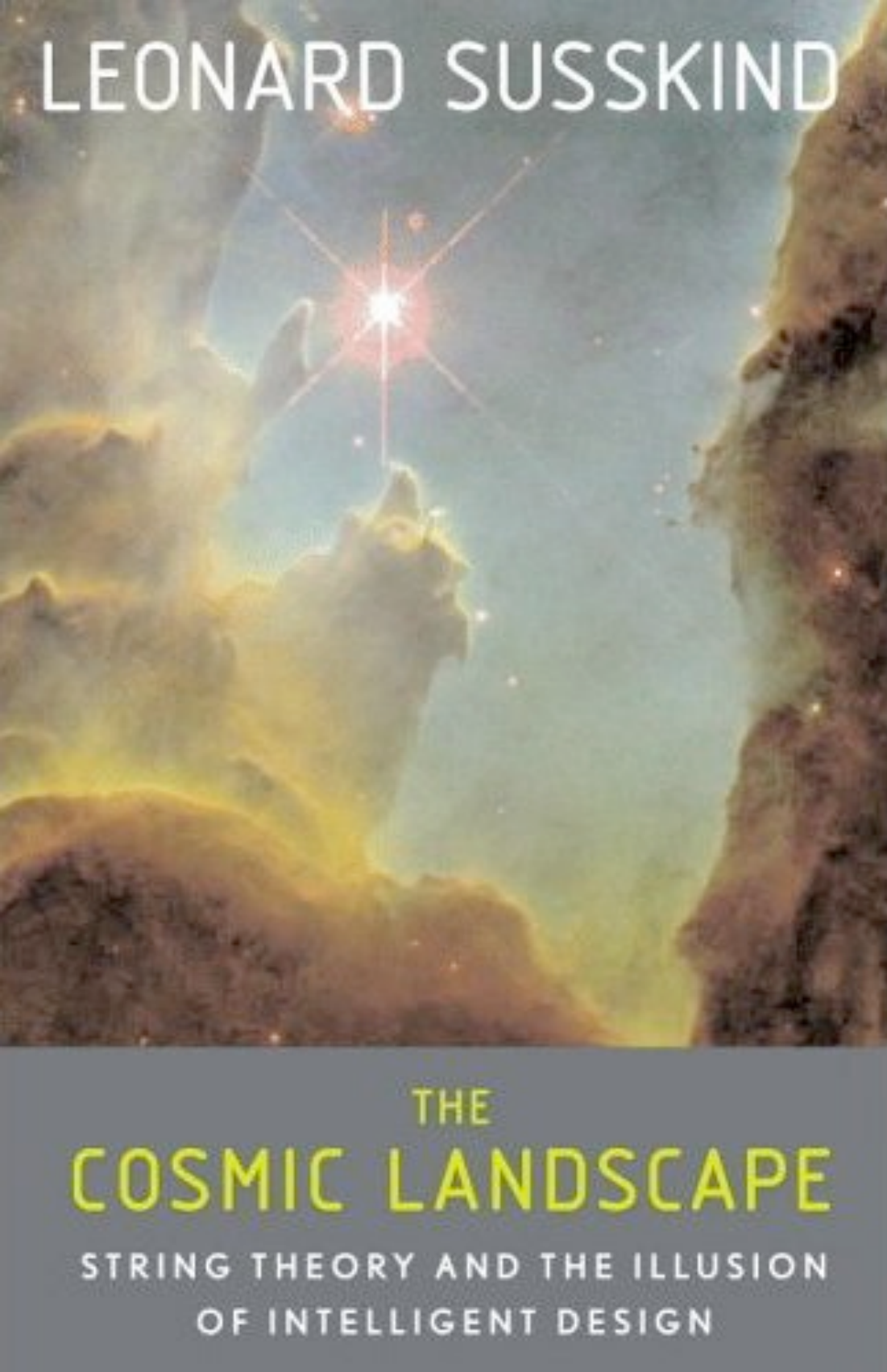

LEONARD SUSSKIND

THE
COSMIC LANDSCAPE

STRING THEORY AND THE ILLUSION
OF INTELLIGENT DESIGN

EMBEDDING THE SM

EMBEDDING THE SM

All of this is wrong if the SM is not contained in String Theory.

EMBEDDING THE SM

All of this is wrong if the SM is not contained in String Theory.

This is non-trivial. String Theory does not contain every gauge theory we can build.

EMBEDDING THE SM

All of this is wrong if the SM is not contained in String Theory.

This is non-trivial. String Theory does not contain every gauge theory we can build.

For example, try embedding the Periodic System!

TWO ROADS TO THE SM

- Gravity and SM from closed strings:
The Heterotic String
- Gravity from closed strings,
The SM from open strings:
Orientifold models

We can only access a very small part of the Landscape with these methods.

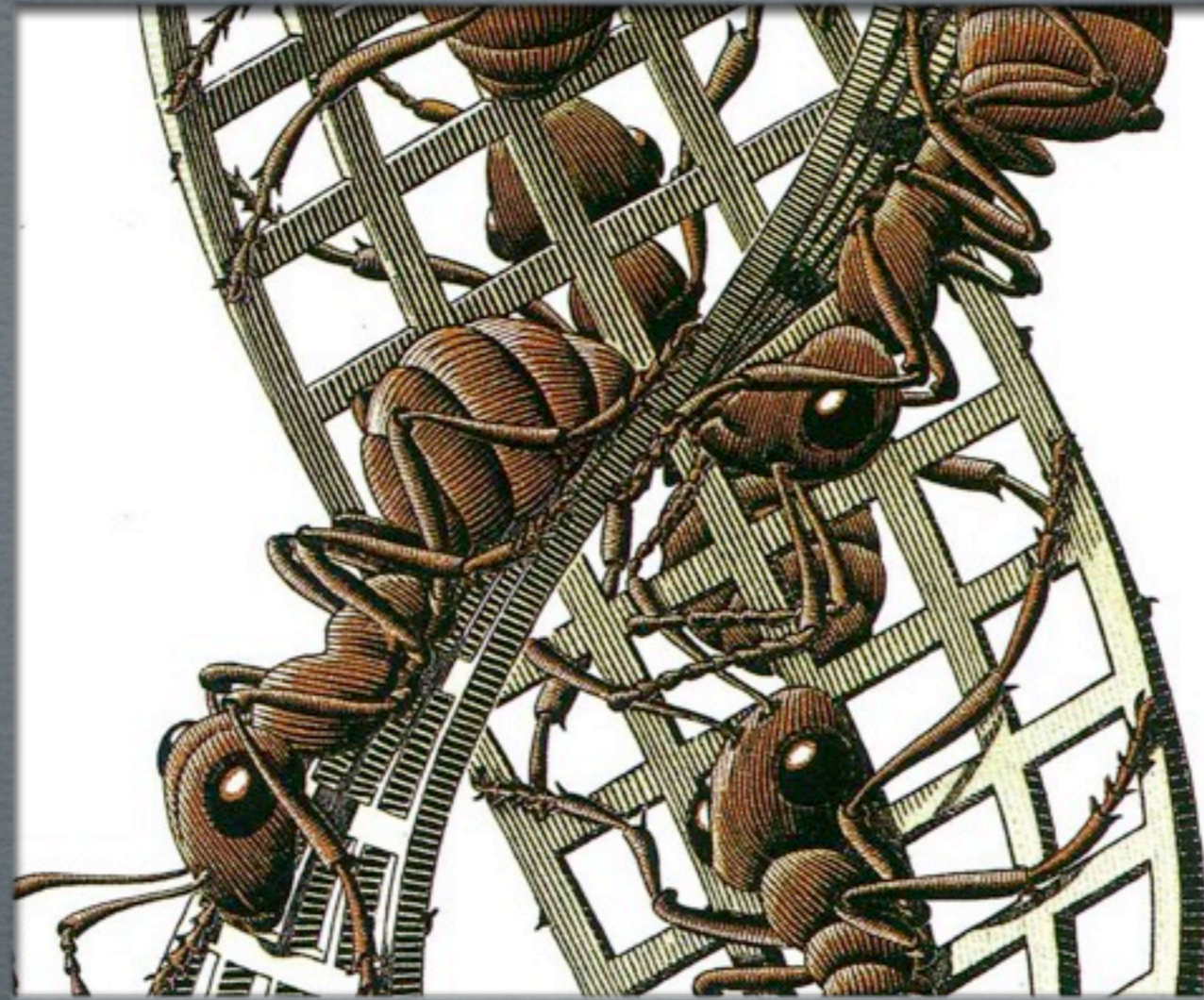

ORIENTIFOLDS

THE LONG ROAD TO THE CHIRAL SSM

- Angelantonj, Bianchi, Pradisi, Sagnotti, Stanev (1996)
Chiral spectra from Orbifold-Orientifolds
- Aldazabal, Franco, Ibanez, Rabadan, Uranga (2000)
Blumenhagen, Görlich, Körs, Lüst (2000)
Ibanez, Marchesano, Rabadan (2001)
Non-supersymmetric SM-Spectra with RR tadpole cancellation
- Cvetič, Shiu, Uranga (2001)
Supersymmetric SM-Spectra with chiral exotics
- Blumenhagen, Görlich, Ott (2002)
Honecker (2003)
Supersymmetric Pati-Salam Spectra with brane recombination
- Dijkstra, Huiszoon, Schellekens (2004)
Supersymmetric Standard Model (Gepner Orientifolds)
- Honecker, Ott (2004)
Supersymmetric Standard Model (Z_6 orbifold/orientifold)

ORIENTIFOLD PARTITION FUNCTIONS

$\frac{1}{2}$

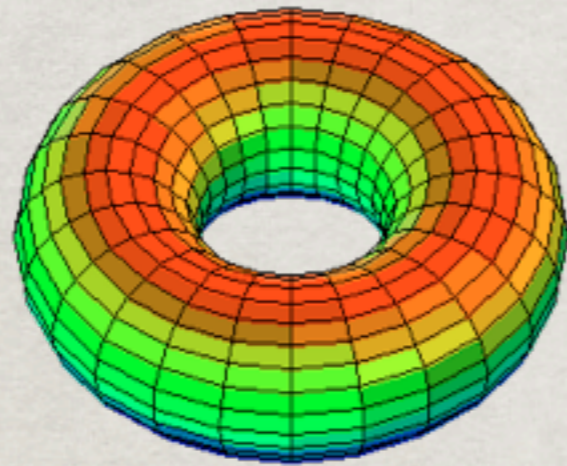

+

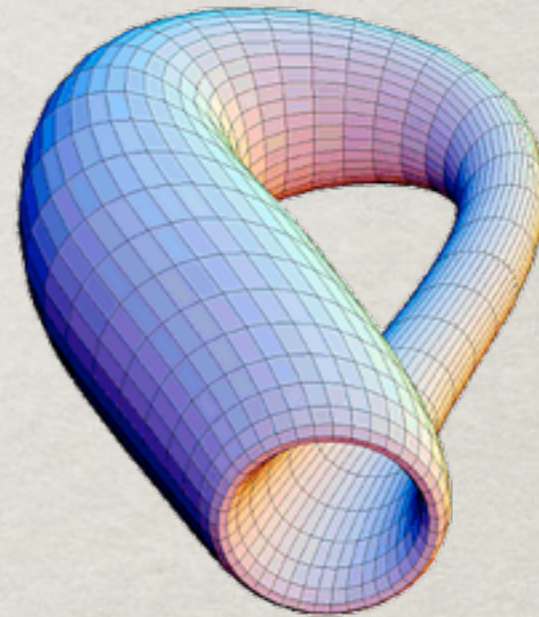

$\frac{1}{2}$

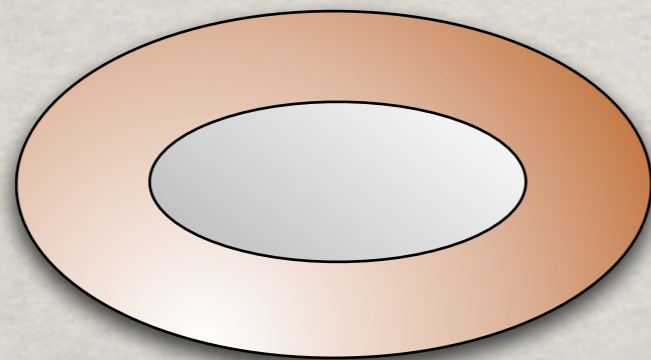

+

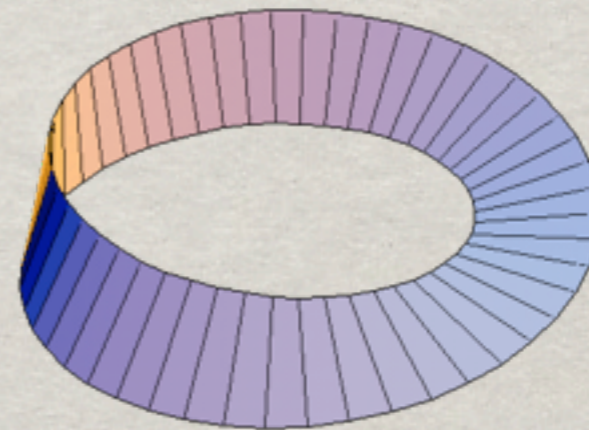

ORIENTIFOLD PARTITION FUNCTIONS

 Closed $\frac{1}{2} \left[\sum_{ij} \chi_i(\tau) Z_{ij} \chi_i(\bar{\tau}) + \sum_i K_i \chi_i(2\tau) \right]$

 Open $\frac{1}{2} \left[\sum_{i,a,n} N_a N_b A^i_{ab} \chi_i\left(\frac{\tau}{2}\right) + \sum_{i,a} N_a M^i_a \hat{\chi}_i\left(\frac{\tau}{2} + \frac{1}{2}\right) \right]$

i : Primary field label (finite range)

a : Boundary label (finite range)

χ_i : Character

N_a : Chan-Paton (CP) Multiplicity

TRANSVERSE CHANNEL

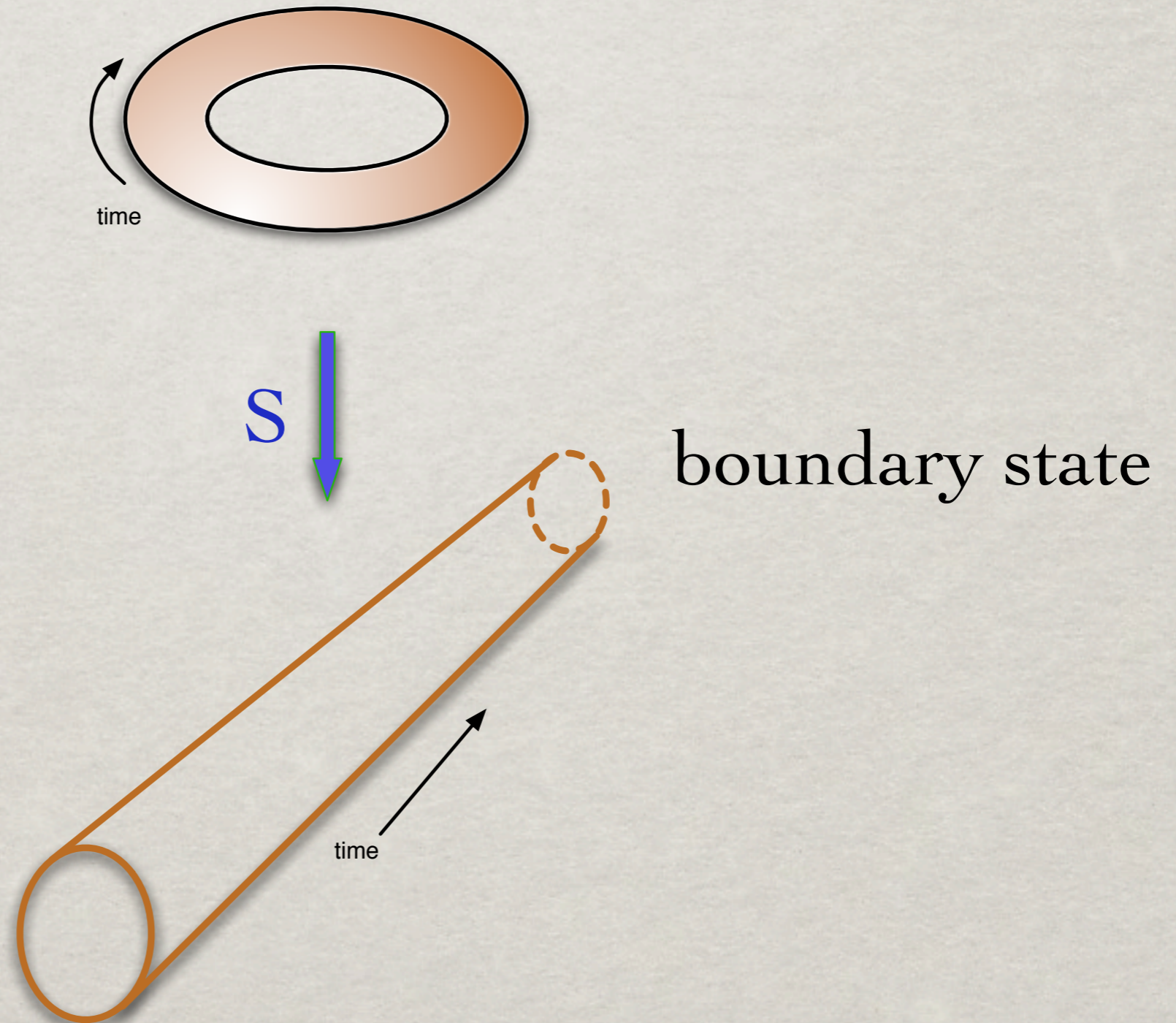

TRANSVERSE CHANNEL

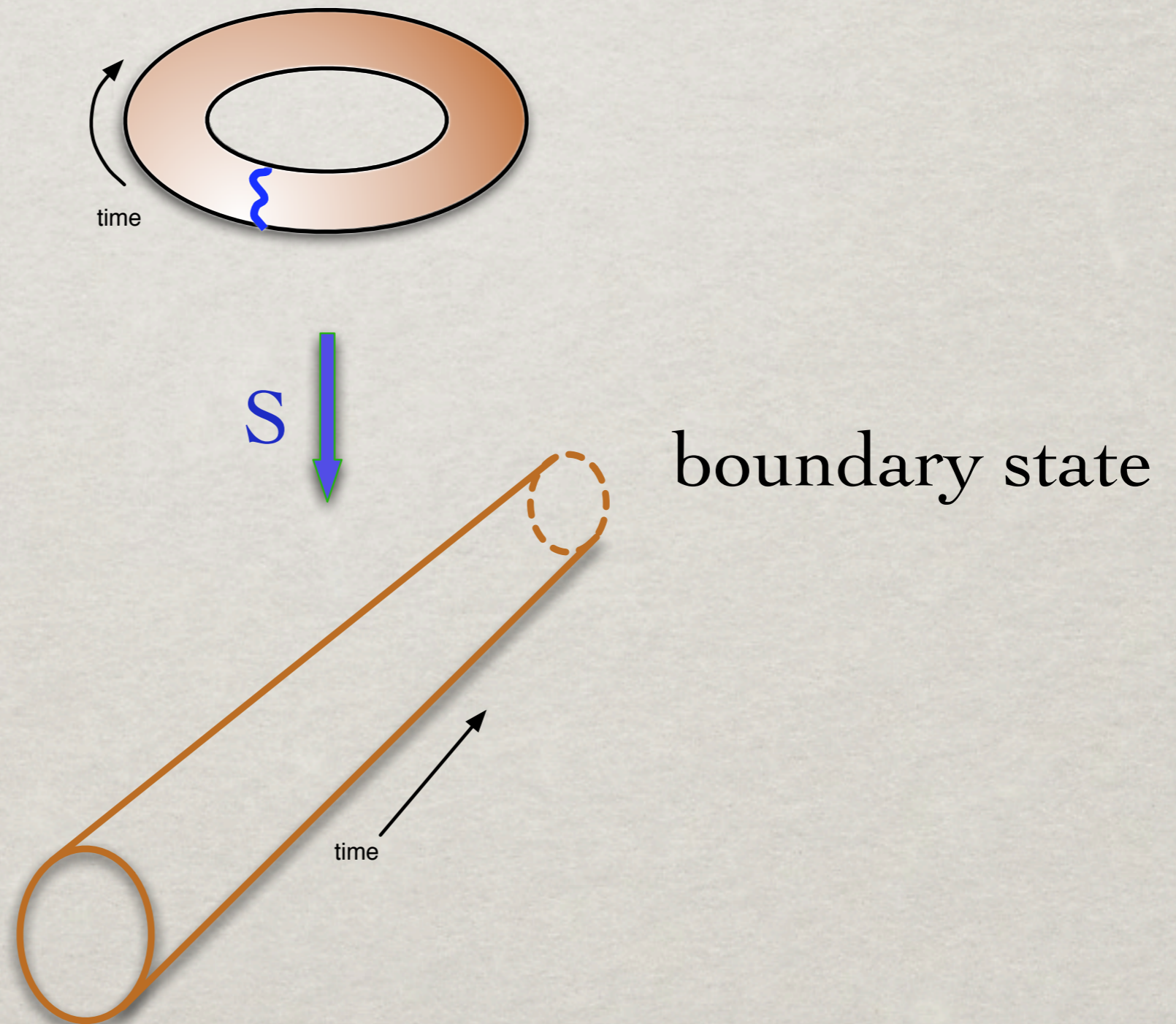

TRANSVERSE CHANNEL

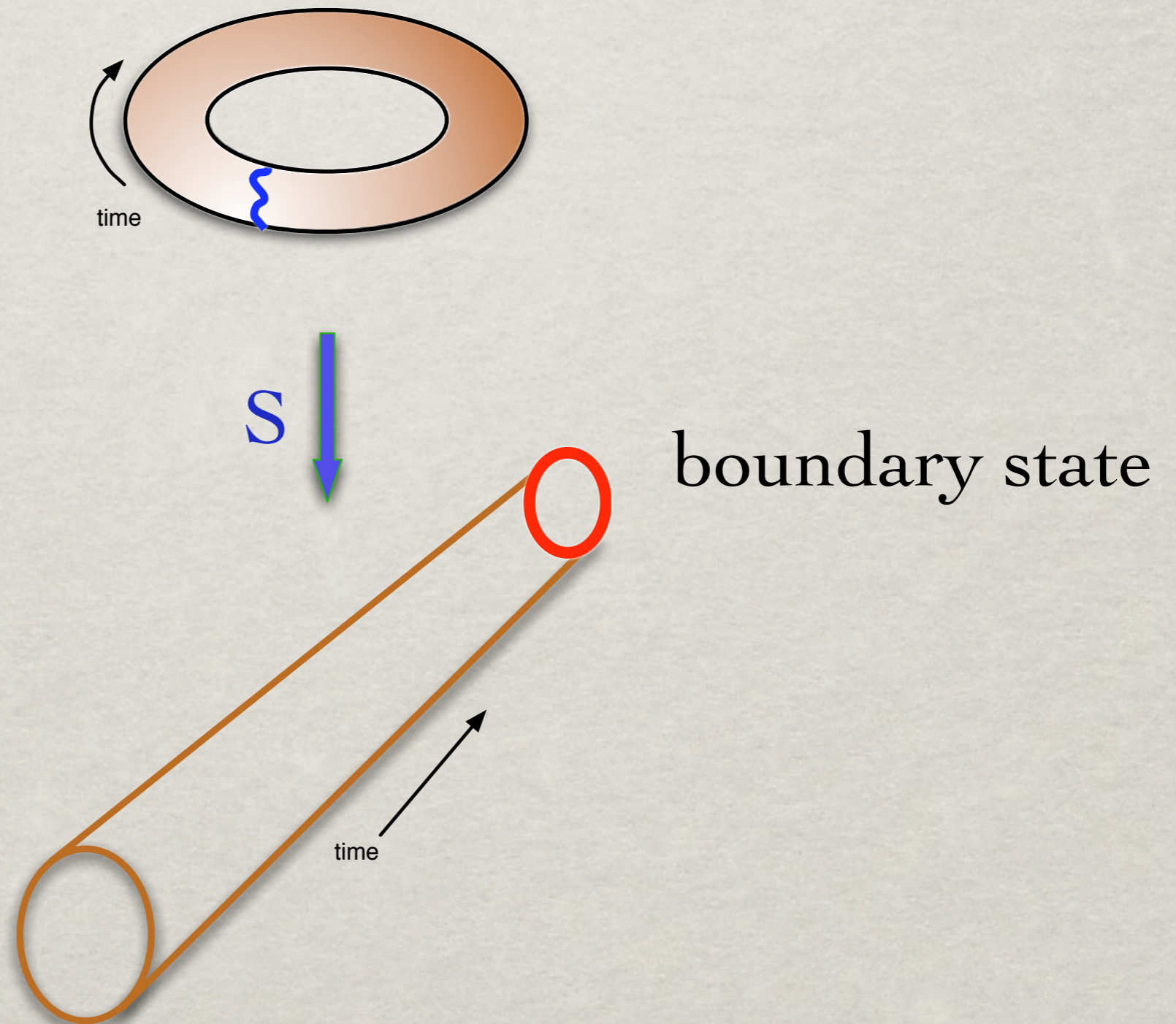

COEFFICIENTS

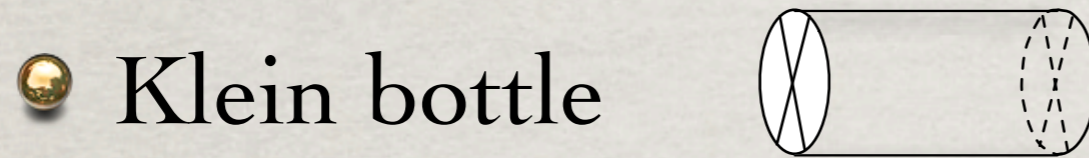

$$K^i = \sum_{m,J,J'} \frac{S_m^i U_{(m,J)} g_{J,J'}^{\Omega,m} U_{(m,J')}}{S_{0m}}$$

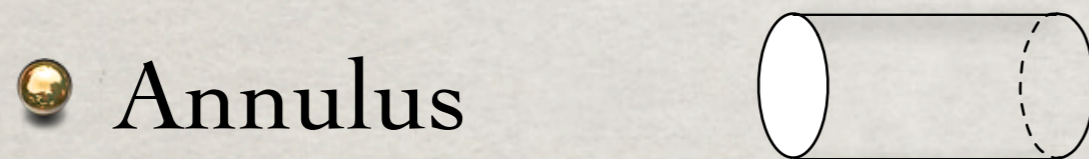

$$A_{[a,\psi_a][b,\psi_b]}^i = \sum_{m,J,J'} \frac{S_m^i R_{[a,\psi_a]}(m,J) g_{J,J'}^{\Omega,m} R_{[b,\psi_b]}(m,J')}{S_{0m}}$$

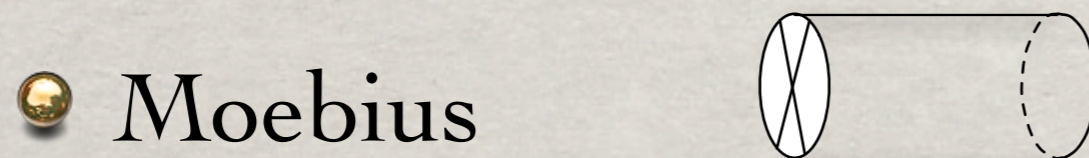

$$M_{[a,\psi_a]}^i = \sum_{m,J,J'} \frac{P_m^i R_{[a,\psi_a]}(m,J) g_{J,J'}^{\Omega,m} U_{(m,J')}}{S_{0m}}$$

$$g_{J,J'}^{\Omega,m} = \frac{S_{m0}}{S_{mK}} \beta_K(J) \delta_{J',J^c}$$



RCFT TOOLS

BOUNDARIES AND CROSSCAPS

- Boundary coefficients

$$R_{[a,\psi_a](m,J)} = \sqrt{\frac{|\mathcal{H}|}{|C_a||S_a|}} \psi_a^*(J) S_{am}^J$$

- Crosscap coefficients

$$U_{(m,J)} = \frac{1}{\sqrt{|\mathcal{H}|}} \sum_{L \in \mathcal{H}} e^{\pi i(h_K - h_{KL})} \beta_K(L) P_{LK,m} \delta_{J,0}$$

Cardy (1989)

Sagnotti, Pradisi, Stanev (~1995)

Huiszoon, Fuchs, Schellekens, Schweigert, Walcher (2000)

A MIPF

$$\sum_{ij} \chi_i(\tau) Z_{ij} \bar{\chi}_j(\bar{\tau})$$

A MIPF

$$\begin{aligned} & (0+2)^2 + (1+3)^2 + (4+6)*(13+15) + (5+7)*(12+14) \\ & + (8+10)^2 + (9+11)^2 + (12+14)*(5+7) + (13+15)*(4+6) \\ + & (16+18)*(25+27) + (17+19)*(24+26) + (20+22)^2 + (21+23)^2 \\ + & (24+26)*(17+19) + (25+27)*(16+18) + (28+30)^2 + (29+31)^2 \\ + & (32+34)^2 + (33+35)^2 + (36+38)*(45+47) + (37+39)*(44+46) \\ + & (40+42)^2 + (41+43)^2 + (44+46)*(37+39) + (45+47)*(36+38) \\ + & (48+50)*(57+59) + (49+51)*(56+58) + (52+54)^2 + (53+55)^2 \\ + & (56+58)*(49+51) + (57+59)*(48+50) + (60+62)^2 + (61+63)^2 \end{aligned}$$

....

$$\begin{aligned} & + 2*(2913)*(2915) + 2*(2914)*(2912) + 2*(2915)*(2913) \\ & + 2*(2916)^2 + 2*(2917)^2 + 2*(2918)^2 + 2*(2919)^2 \\ & + 2*(2920)^2 + 2*(2921)^2 + 2*(2922)^2 + 2*(2923)^2 \\ + & 2*(2924)*(2926) + 2*(2925)*(2927) + 2*(2926)*(2924) \\ + & 2*(2927)*(2925) + 2*(2928)^2 + 2*(2929)^2 + 2*(2930)^2 \\ & + 2*(2931)^2 + 2*(2932)*(2934) + 2*(2933)*(2935) \\ + & 2*(2934)*(2932) + 2*(2935)*(2933) + 2*(2936)*(2938) \\ + & 2*(2937)*(2939) + 2*(2938)*(2936) + 2*(2939)*(2937) \\ & + 2*(2940)^2 + 2*(2941)^2 + 2*(2942)^2 + 2*(2943)^2 \end{aligned}$$

ISHIBASHI STATES

$$(0+2)^2 + (1+3)^2 + (4+6)*(13+15) + (5+7)*(12+14) \\ + (8+10)^2 + (9+11)^2 + (12+14)*(5+7) + (13+15)*(4+6)$$

.....

$$+ 2*(2937)*(2939) + 2*(2938)*(2936) + 2*(2939)*(2937) \\ + 2*(2940)^2 + 2*(2941)^2 + 2*(2942)^2 + 2*(2943)^2$$

ISHIBASHI STATES

$$\begin{aligned} & (0+2)^2 + (1+3)^2 + (4+6)*(13+15) + (5+7)*(12+14) \\ & + (8+10)^2 + (9+11)^2 + (12+14)*(5+7) + (13+15)*(4+6) \end{aligned}$$

.....

$$\begin{aligned} & + 2*(2937)*(2939) + 2*(2938)*(2936) + 2*(2939)*(2937) \\ & + 2*(2940)^2 + 2*(2941)^2 + 2*(2942)^2 + 2*(2943)^2 \end{aligned}$$

ISHIBASHI STATES

$$\begin{aligned} & (0+2)^2 + (1+3)^2 + (4+6) \cdot (13+15) + (5+7) \cdot (12+14) \\ & + (8+10)^2 + (9+11)^2 + (12+14) \cdot (5+7) + (13+15) \cdot (4+6) \end{aligned}$$

.....

$$\begin{aligned} & + 2 \cdot (2937) \cdot (2939) + 2 \cdot (2938) \cdot (2936) + 2 \cdot (2939) \cdot (2937) \\ & + 2 \cdot (2940)^2 + 2 \cdot (2941)^2 + 2 \cdot (2942)^2 + 2 \cdot (2943)^2 \end{aligned}$$

$$(m, J) : J \in \mathcal{S}_m$$

with $Q_L(m) + X(L, J) = 0 \pmod{1}$ for all $L \in \mathcal{H}$

$$\mathcal{S}_m : J \in \mathcal{H} \text{ with } J \cdot m = m$$

(Stabilizer of m)

BOUNDARY STATES

$$(0+2)^2 + (1+3)^2 + (4+6)*(13+15) + (5+7)*(12+14) \\ + (8+10)^2 + (9+11)^2 + (12+14)*(5+7) + (13+15)*(4+6)$$

.....

$$+ 2*(2937)*(2939) + 2*(2938)*(2936) + 2*(2939)*(2937) \\ + 2*(2940)^2 + 2*(2941)^2 + 2*(2942)^2 + 2*(2943)^2$$

BOUNDARY STATES

$$\begin{aligned} & (0+2)^2 + (1+3)^2 + (4+6) * (13+15) + (5+7) * (12+14) \\ & + (8+10)^2 + (9+11)^2 + (12+14) * (5+7) + (13+15) * (4+6) \end{aligned}$$

.....

$$\begin{aligned} & + 2 * (2937) * (2939) + 2 * (2938) * (2936) + 2 * (2939) * (2937) \\ & + 2 * (2940)^2 + 2 * (2941)^2 + 2 * (2942)^2 + 2 * (2943)^2 \end{aligned}$$

BOUNDARY STATES

$$\begin{aligned} & (0+2)^2 + (1+3)^2 + (4+6) * (13+15) + (5+7) * (12+14) \\ & + (8+10)^2 + (9+11)^2 + (12+14) * (5+7) + (13+15) * (4+6) \end{aligned}$$

.....

$$\begin{aligned} & + 2 * (2937) * (2939) + 2 * (2938) * (2936) + 2 * (2939) * (2937) \\ & + 2 * (2940)^2 + 2 * (2941)^2 + 2 * (2942)^2 + 2 * (2943)^2 \end{aligned}$$

$[a, \psi_a]$, ψ_a is a character of the group C_a

C_a is the Central Stabilizer of a

$$C_i := \{J \in \mathcal{S}_i \mid F_i^X(K, J) = 1 \text{ for all } K \in \mathcal{S}_i\}$$

$$F_i^X(K, J) := e^{2\pi i X(K, J)} F_i(K, J)^*$$

$$S_{Ki, j}^J = F_i(K, J) e^{2\pi i Q_K(j)} S_{i, j}^J.$$

ACCESSIBLE RCFT'S

- “Gepner Models” (*)
(minimal $N=2$ tensor products)
- Free fermions ($4n$ real + $(9-2n)$ complex)
- Kazama-Suzuki models
(requires exact spectrum computation)
- Permutation orbifolds
-

(*) See also: Angelantonj et. al.
Blumenhagen et. al.
Aldazabal et. al.
Brunner et. al.

ALGEBRAIC CHOICES

- Basic CFT ($N=2$ tensor, free fermions...)
(Type IIB closed string theory)
- Chiral algebra extension(*)
May imply space-time symmetry (e.g. Susy: GSO projection).
Reduces number of characters.
- Modular Invariant Partition Function (MIPF)(*)
May imply bulk symmetry (e.g. Susy), not respected by all boundaries.
Defines the set of boundary states
(Sagnotti-Pradisi-Stanev completeness condition)
- Orientifold choice(*)

(*) all these choices are simple current related

TADPOLES & ANOMALIES

- Tadpole cancellation condition:

$$\sum_b N_b R_{b(m,J)} = 4\eta_m U_{(m,J)}$$

- Cubic anomalies cancel

- Remaining anomalies by Green-Schwarz mechanism

- In rare cases, additional conditions for global anomaly cancellation*

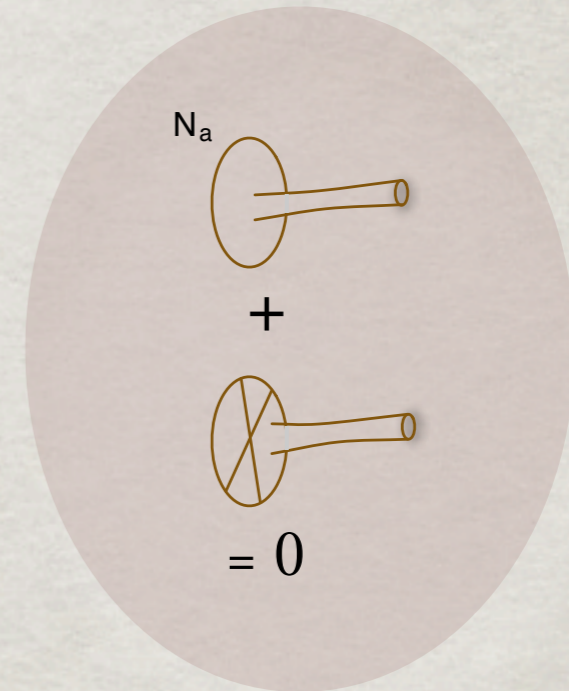

*Gato-Rivera, Schellekens (2005)



MODEL BUILDING

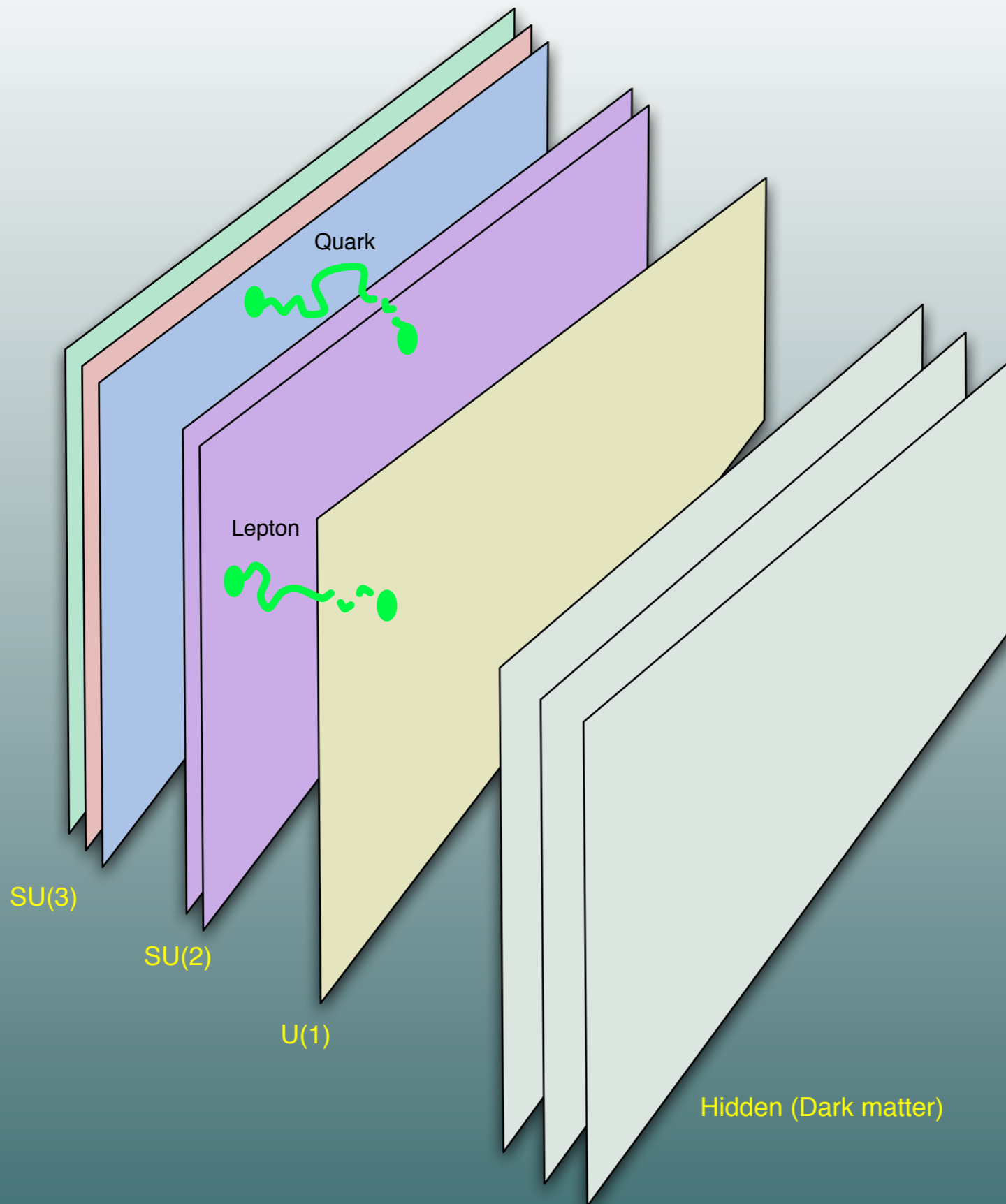

THE MADRID MODEL*

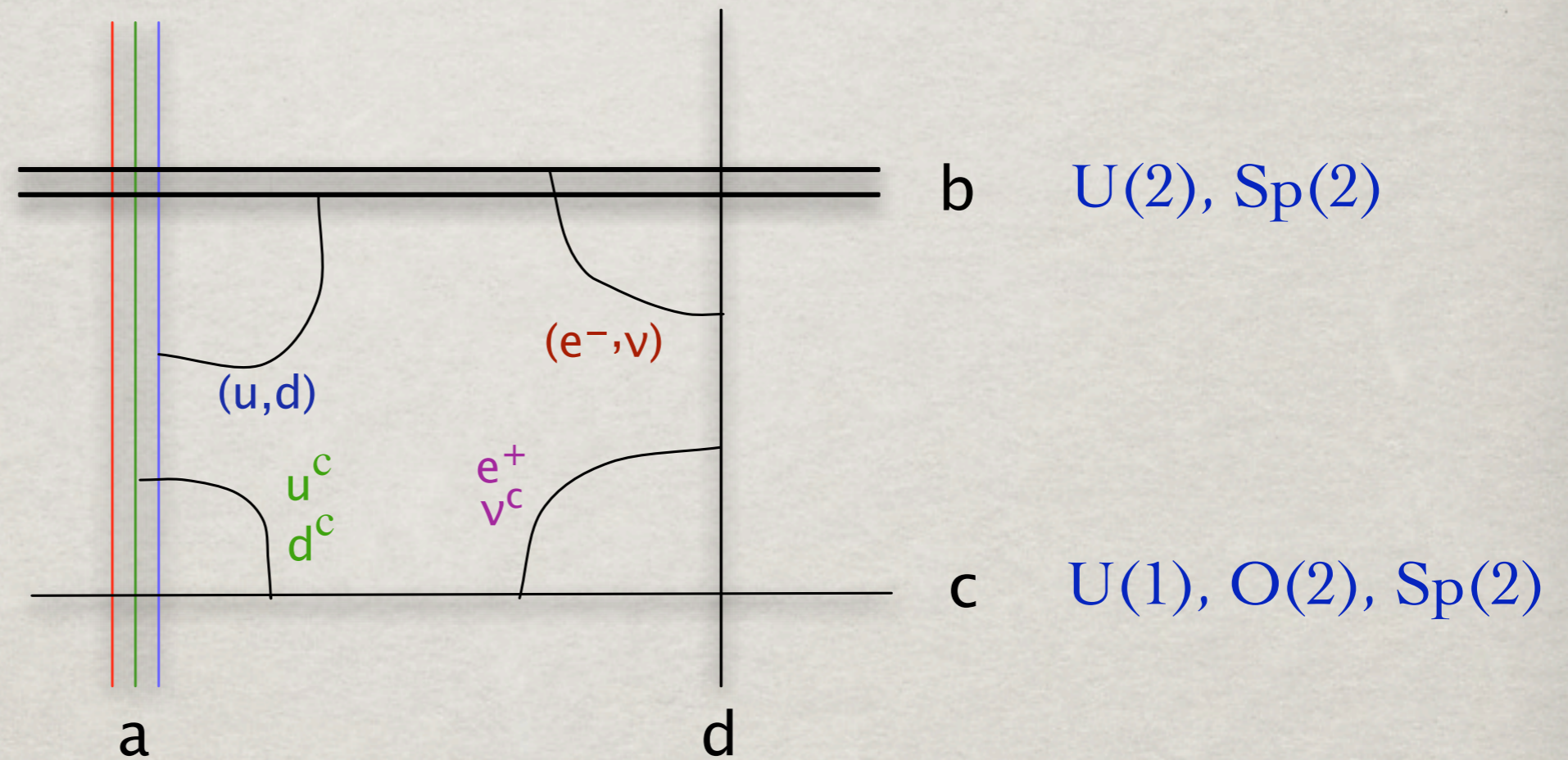

$$Y = \frac{1}{6}Q_a - \frac{1}{2}Q_c - \frac{1}{2}Q_d$$

(*) *Ibanez, Marchesano, Rabadan*

ABELIAN MASSES

Green-Schwarz mechanism

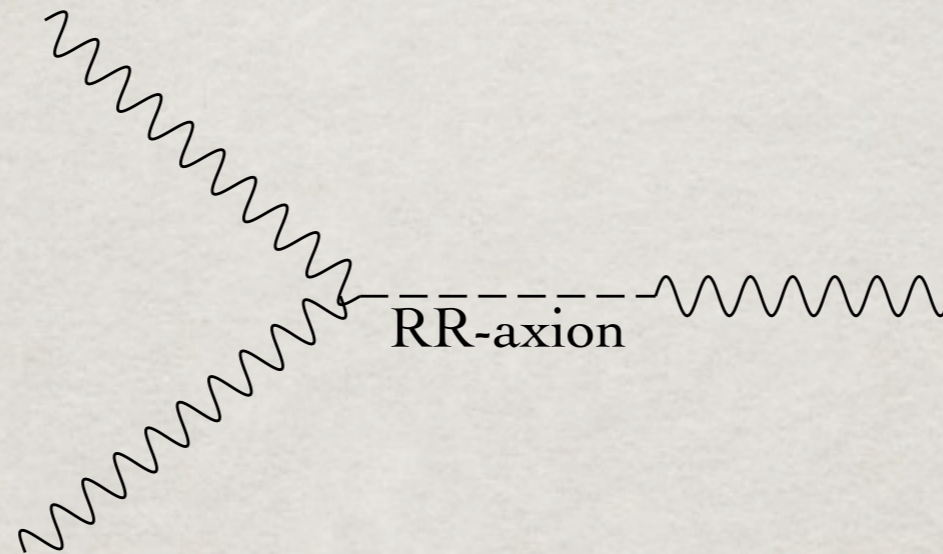

Axion-Vector boson vertex

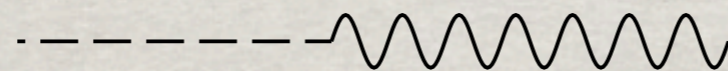

Generates mass vector bosons of anomalous symmetries

(*e.g.* $B + L$)

But may also generate mass for non-anomalous ones

($Y, B - L$)

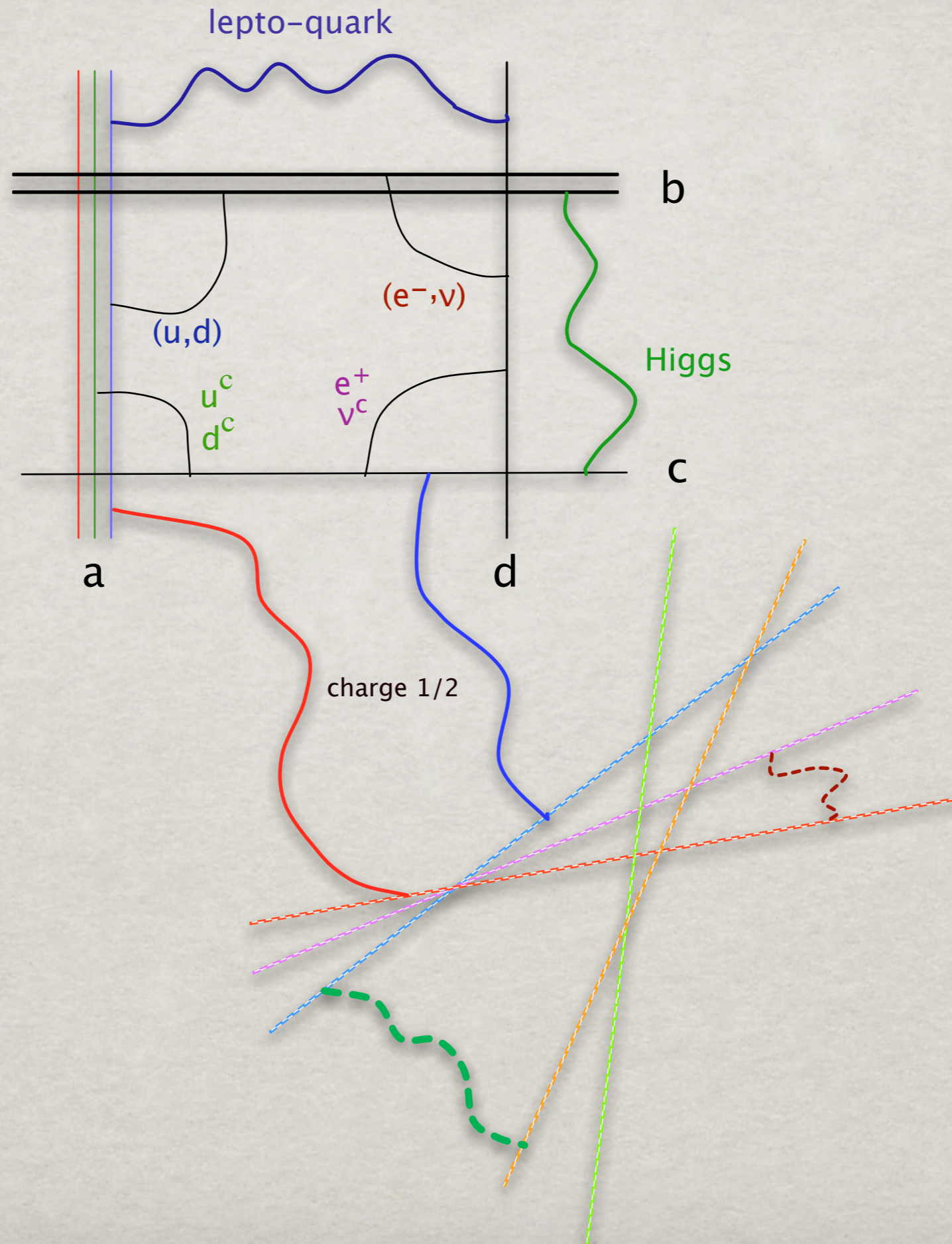

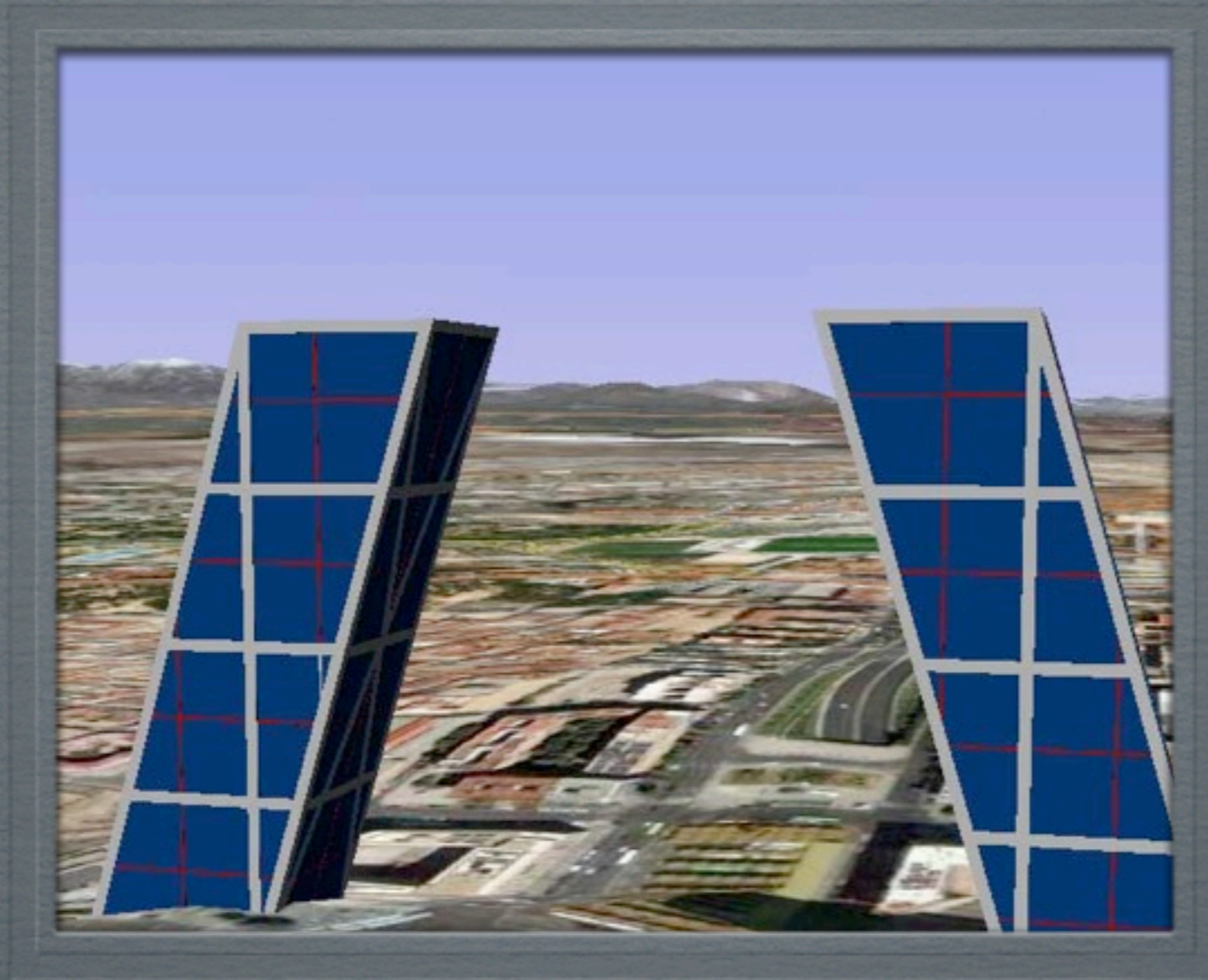

BEYOND MADRID

THE SM SPECTRUM

Current experimental information:

3 chiral families + vector-like states

Possible vector-like states:

Higgs?

right-handed neutrinos?

squarks, sleptons?

gluinos?

who knows what else?

(Some constraints from unification, if you believe it)

MODELS

3 families
+ anything vector-like

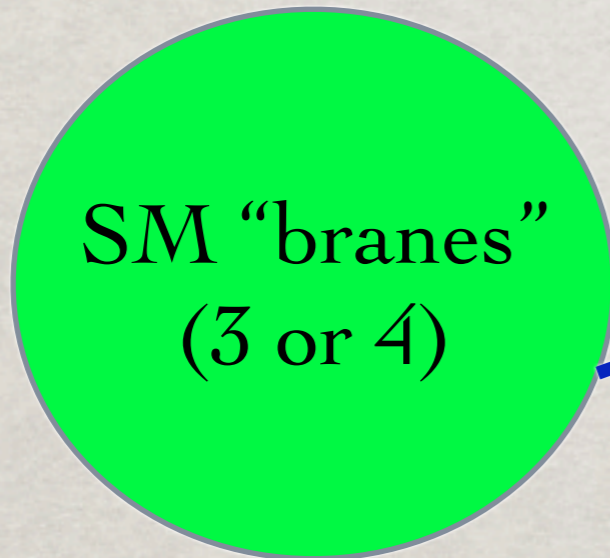

Anything that cancels the tadpoles
(not always needed)

Fully vector-like
(not always present)

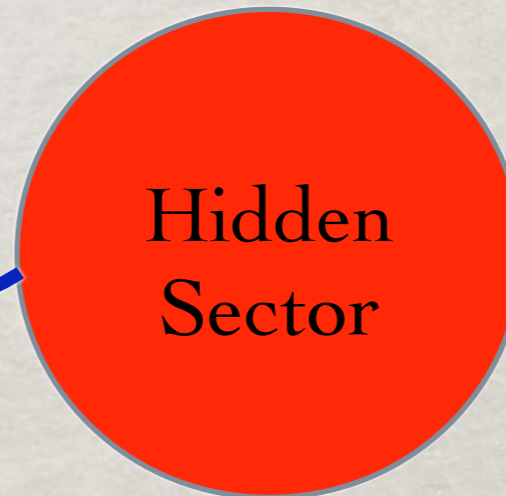

Vector-like: mass allowed by $SU(3) \times SU(2) \times U(1)$
(Higgs, right-handed neutrino, gauginos, sparticles....)

SEARCH CRITERIA

Require only:

- $U(3)$ from a single brane
- $U(2)$ from a single brane
- Quarks and leptons, Y from at most four branes
- $G_{\text{CP}} \supset SU(3) \times SU(2) \times U(1)$
- Chiral G_{CP} fermions reduce to quarks, leptons (plus non-chiral particles)
- Massless Y

ALLOWED FEATURES

- (Anti)-quarks from anti-symmetric tensors
- Leptons from anti-symmetric tensors
- Family symmetries
- Non-standard Y-charge assignments
- Unification (Pati-Salam, (flipped) $SU(5)$, trinification)*
- Baryon and/or lepton number violation
-

*a,b,c,d may be identical

CHAN-PATON GROUP

$$G_{CP} = U(3)_a \times \left\{ \begin{array}{l} U(2)_b \\ Sp(2)_b \end{array} \right\} \times G_c \quad (\times G_d)$$

Embedding of Y:

$$Y = \alpha Q_a + \beta Q_b + \gamma Q_c + \delta Q_d + W_c + W_d$$

Q: Brane charges (for unitary branes)

W: Traceless generators

CLASSIFICATION

$$Y = \left(x - \frac{1}{3}\right)Q_a + \left(x - \frac{1}{2}\right)Q_b + \underbrace{xQ_c + (x - 1)Q_d}_{\text{Distributed over c and d}}$$

Distributed over
c and d

Allowed values for x

1/2	Madrid model, Pati-Salam, Flipped SU(5)
0	(broken) SU(5)
1	Antoniadis, Kiritsis, Tomaras model
-1/2, 3/2	
any	Trinification ($x = 1/3$) (orientable)



SEARCHES

TORUS CFT: TYPE-IIB GEPNER MODELS

Building Blocks:
Minimal N=2 CFT

$$c = \frac{3k}{k+2}, \quad k = 1, \dots, \infty$$

168 ways of solving $\sum_i c_{k_i} = 9$

Spectrum:

$$h_{l,m} = \frac{l(l+2) - m^2}{4(k+2)} + \frac{s^2}{8}$$

$$(l = 0, \dots, k; \quad q = -k, \dots, k+2; \quad s = -1, 0, 1, 2)$$

(plus field identification)

$4(k+2)$ simple currents

DATA

	2004-2005*	2005-2006†
Trigger	“Madrid”	All 3 family models
Chiral types	19	19345
Tadpole-free(per type)	18	1900
Total configs	45×10^6	145×10^6
Tadpole free, distinct	210.000	1900
Max. primaries	∞	1750

(*) Huiszoon, Dijkstra, Schellekens

(†) Anastasopoulos, Dijkstra, Kiritsis, Schellekens

A “MADRID” MODEL

Gauge group: Exactly $SU(3) \times SU(2) \times U(1)$!

$[U(3) \times Sp(2) \times U(1) \times U(1)$, Massive B-L, No hidden sector]

3 x (V ,V ,0 ,0)	chirality 3	Q
3 x (V ,0 ,V ,0)	chirality -3	U*
3 x (V ,0 ,V* ,0)	chirality -3	D*
3 x (0 ,V ,0 ,V)	chirality 3	L
5 x (0 ,0 ,V ,V)	chirality -3	E* + (E+E*)
3 x (0 ,0 ,V ,V*)	chirality 3	N*
18 x (0 ,V ,V ,0)		Higgs
2 x (V ,0 ,0 ,V)		
2 x (Ad ,0 ,0 ,0)		
2 x (A ,0 ,0 ,0)		
6 x (S ,0 ,0 ,0)		
14 x (0 ,A ,0 ,0)		
6 x (0 ,S ,0 ,0)		
9 x (0 ,0 ,Ad ,0)		
6 x (0 ,0 ,A ,0)		
14 x (0 ,0 ,S ,0)		
3 x (0 ,0 ,0 ,Ad)		
4 x (0 ,0 ,0 ,A)		
6 x (0 ,0 ,0 ,S)		

A “MADRID” MODEL

Gauge group: Exactly $SU(3) \times SU(2) \times U(1)$!

$[U(3) \times Sp(2) \times U(1) \times U(1)$, Massive B-L, No hidden sector]

3 x (V ,V ,0 ,0)	chirality 3	Q
3 x (V ,0 ,V ,0)	chirality -3	U*
3 x (V ,0 ,V* ,0)	chirality -3	D*
3 x (0 ,V ,0 ,V)	chirality 3	L
5 x (0 ,0 ,V ,V)	chirality -3	E* + (E+E*)
3 x (0 ,0 ,V ,V*)	chirality 3	N*
18 x (0 ,V ,V ,0)		Higgs

2 x (V ,0 ,0 ,V)
2 x (Ad ,0 ,0 ,0)
2 x (A ,0 ,0 ,0)
6 x (S ,0 ,0 ,0)
14 x (0 ,A ,0 ,0)
6 x (0 ,S ,0 ,0)
9 x (0 ,0 ,Ad ,0)
6 x (0 ,0 ,A ,0)
14 x (0 ,0 ,S ,0)
3 x (0 ,0 ,0 ,Ad)
4 x (0 ,0 ,0 ,A)
6 x (0 ,0 ,0 ,S)

Vector-like matter

V=vector

A=Anti-symm. tensor

S=Symmetric tensor

Ad=Adjoint

NO MIRRORS, NO RANK-2 TENSORS

(Left-right symmetric model)

U3 S2 S2 U1 S6 S4 S2

3 x (V ,V ,0 ,0 ,0 ,0 ,0)	chirality 3	Q
3 x (V ,0 ,V ,0 ,0 ,0 ,0)	chirality -3	U*,D*
3 x (0 ,V ,0 ,V ,0 ,0 ,0)	chirality 3	L
3 x (0 ,0 ,V ,V ,0 ,0 ,0)	chirality -3	E*,N*
2 x (V ,0 ,0 ,V ,0 ,0 ,0)		Leptoquark pair
2 x (0 ,V ,V ,0 ,0 ,0 ,0)		2 Higgs pairs
2 x (V ,0 ,0 ,0 ,V ,0 ,0)		
2 x (V ,0 ,0 ,0 ,0 ,V ,0)		
2 x (V ,0 ,0 ,0 ,0 ,0 ,V)		
1 x (0 ,V ,0 ,0 ,V ,0 ,0)		
1 x (0 ,0 ,V ,0 ,V ,0 ,0)		
2 x (0 ,0 ,0 ,V ,0 ,V ,0)		
1 x (0 ,0 ,0 ,0 ,V ,0 ,V)		
2 x (0 ,0 ,0 ,0 ,0 ,V ,V)		
2 x (0 ,0 ,0 ,0 ,A ,0 ,0)		
1 x (0 ,0 ,0 ,0 ,S ,0 ,0)		
5 x (0 ,0 ,0 ,0 ,0 ,A ,0)		
5 x (0 ,0 ,0 ,0 ,0 ,S ,0)		
1 x (0 ,0 ,0 ,0 ,0 ,0 ,S)		

Total number of Symmetric tensors in SM gauge groups

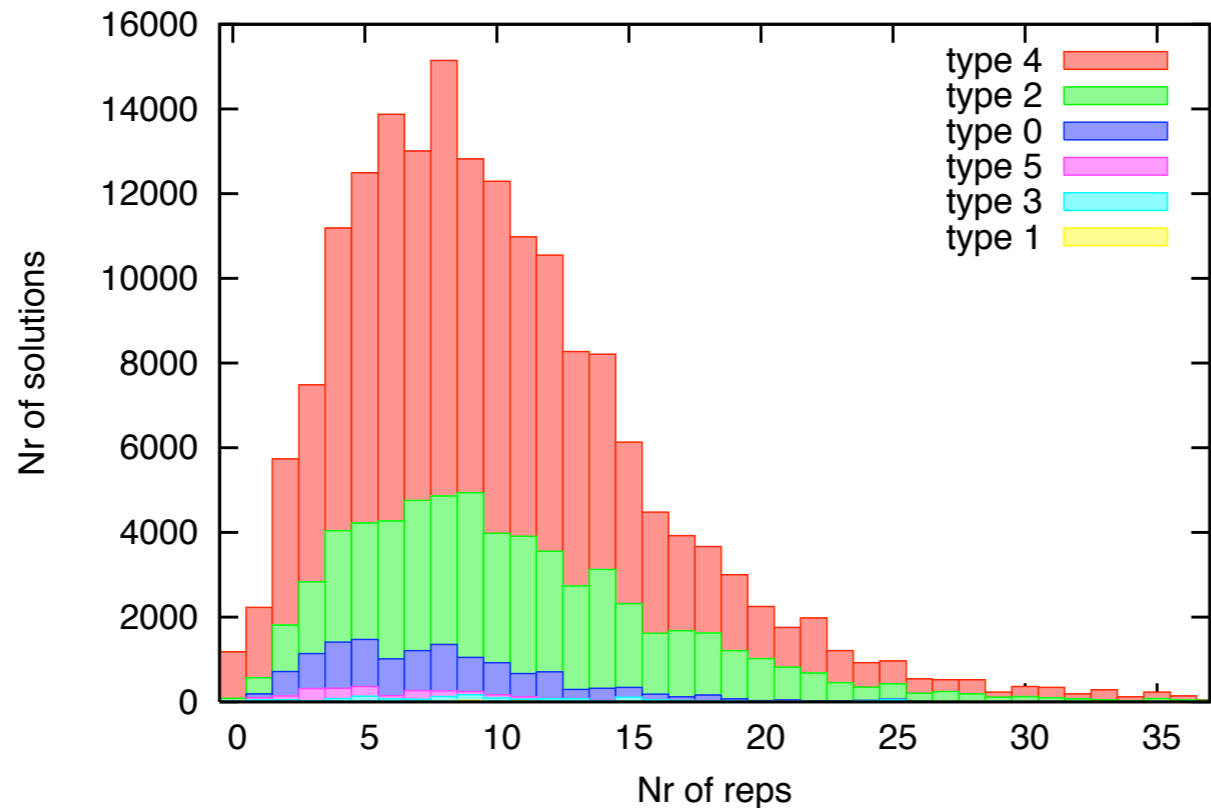

Total number of Anti-symmetric tensors in SM gauge groups

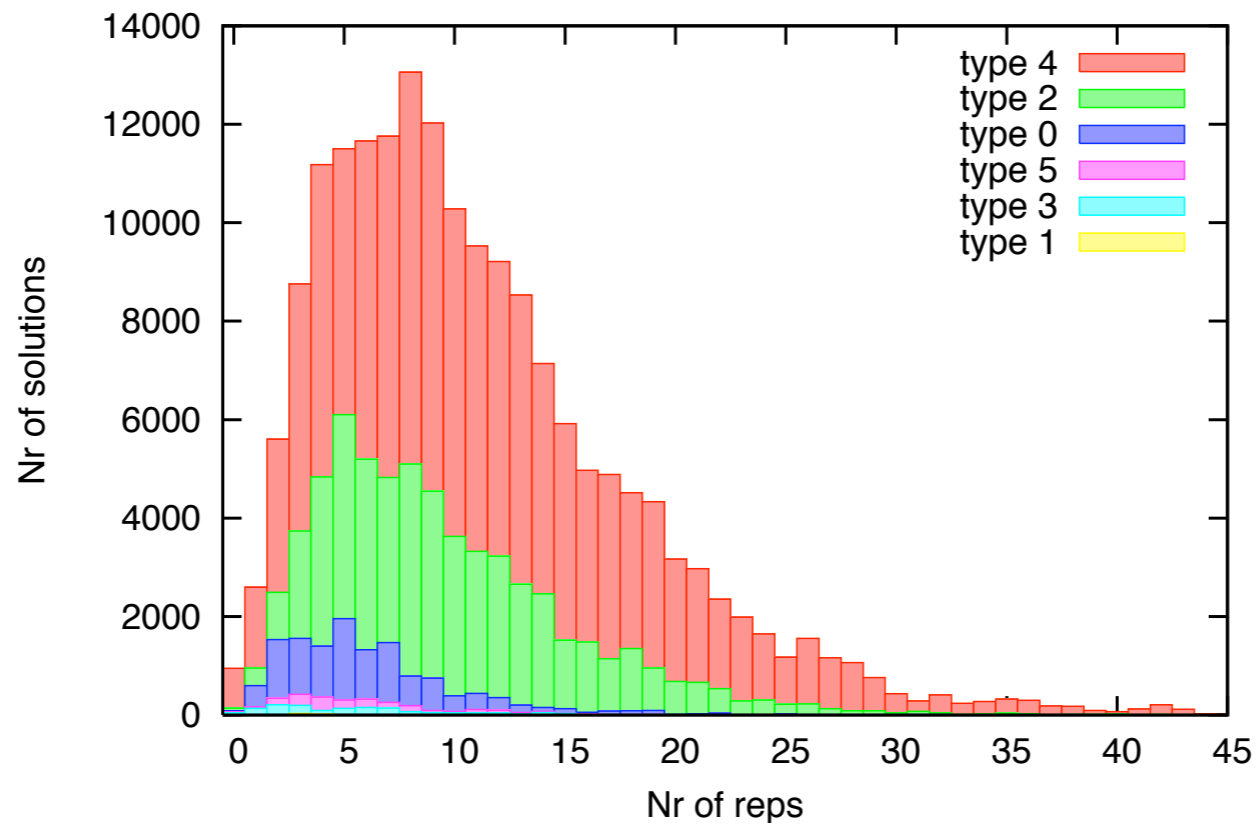

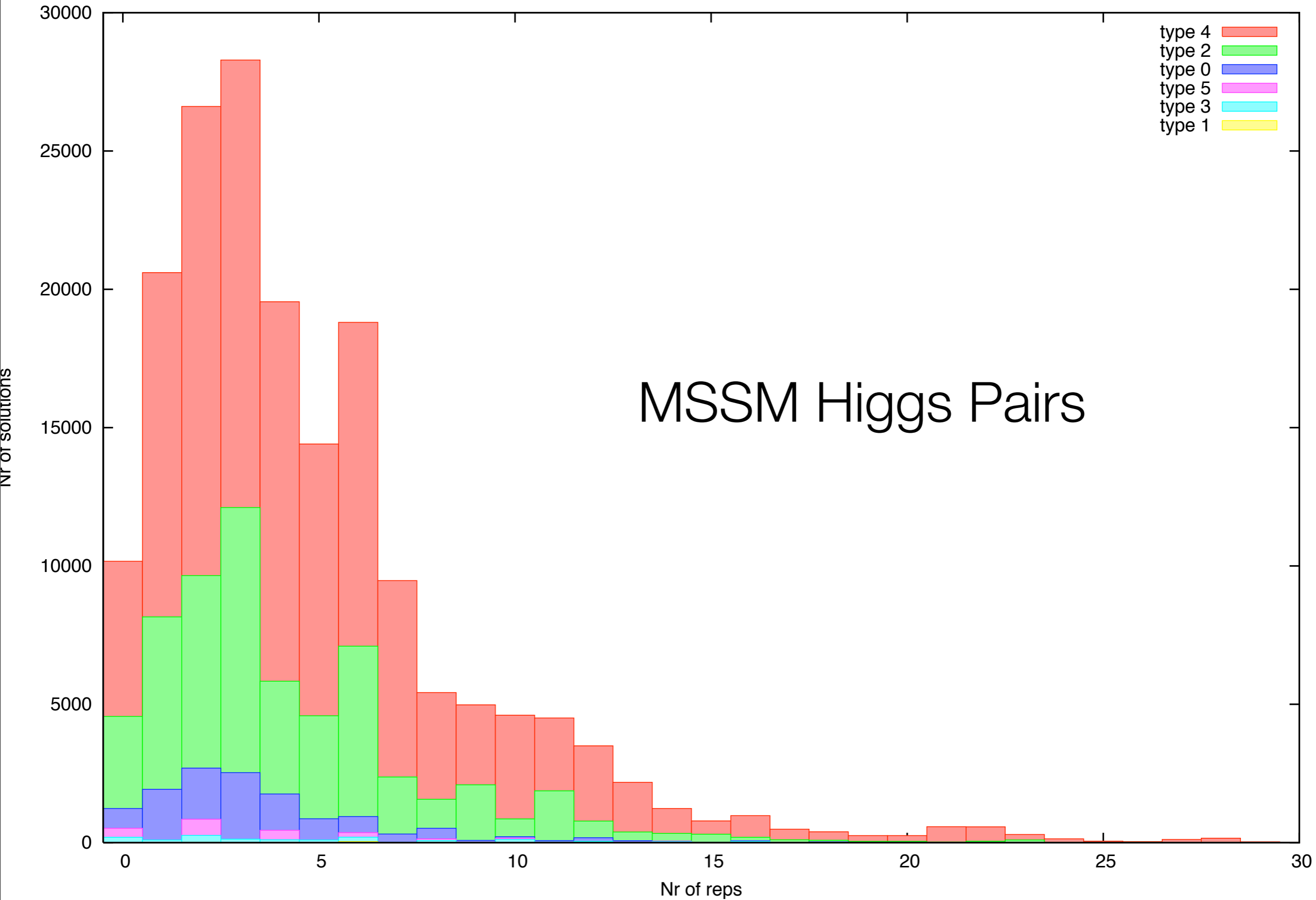

MSSM Higgs Pairs

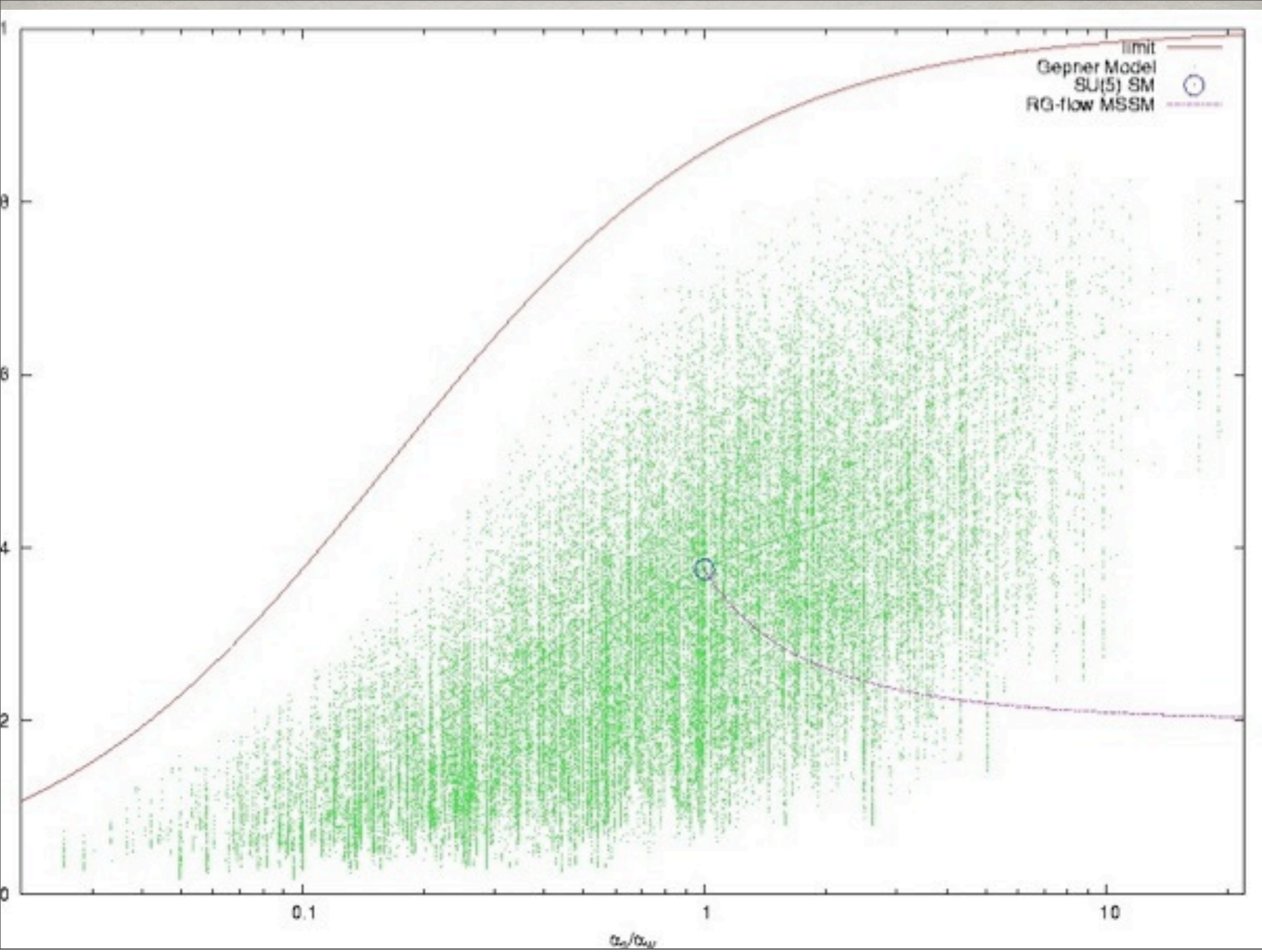

STATISTICS

Value of x	Total
0	24483441
1/2	138837612*
1	30580
-1/2, 3/2	0
any	1250080

*Previous search: 45051902

AN SU(5) MODEL

Gauge group is just SU(5)!

U(5)

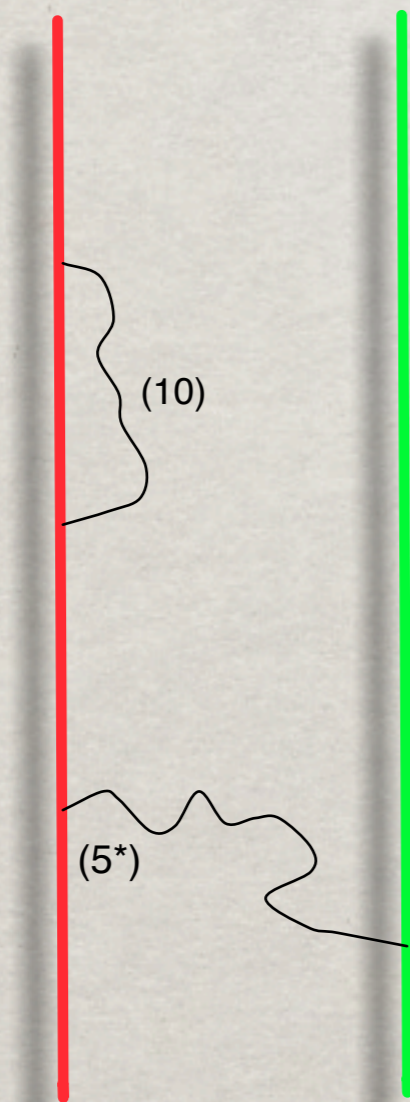

U5 O1 O1

3 x	(A ,0 ,0)	chirality 3
11 x	(V ,V ,0)	chirality -3
8 x	(S ,0 ,0)	
3 x	(Ad ,0 ,0)	
1 x	(0 ,A ,0)	
3 x	(0 ,V ,V)	
8 x	(V ,0 ,V)	
2 x	(0 ,S ,0)	
4 x	(0 ,0 ,S)	
4 x	(0 ,0 ,A)	

Top quark Yukawa's?

A CURIOSITY

Gauge group $SU(3) \times SU(2) \times U(1) \times [U(2)_{\text{Hidden}}]$

U3 S2 U1 U1 U2

3 x (V ,V ,0 ,0 ,0)	chirality 3	Q
3 x (0 ,0 ,V ,V ,0)	chirality -3	E*
1 x (V ,0 ,0 ,V* ,0)	chirality -1	U*
2 x (V ,0 ,V ,0 ,0)	chirality -2	D*
2 x (0 ,V ,0 ,V ,0)	chirality 2	L
3 x (V ,0 ,0 ,V ,0)	chirality -1	D*+(D+D*)
3 x (0 ,V ,V ,0 ,0)	chirality 1	L+H ₁ +H ₂
2 x (V ,0 ,V* ,0 ,0)	chirality -2	U*
1 x (0 ,0 ,V ,V* ,0)	chirality 1	N*
4 x (A ,0 ,0 ,0 ,0)		U+U*
2 x (0 ,0 ,0 ,S ,0)		E+E*

A CURIOSITY

Gauge group $SU(3) \times SU(2) \times U(1) \times [U(2)_{\text{Hidden}}]$

	U3	S2	U1	U1	U2		
3 x	(V	,V	,0	,0	,0)	chirality 3	Q
3 x	(0	,0	,V	,V	,0)	chirality -3	E*
1 x	(V	,0	,0	,V*	,0)	chirality -1	U*
2 x	(V	,0	,V	,0	,0)	chirality -2	D*
2 x	(0	,V	,0	,V	,0)	chirality 2	L
3 x	(V	,0	,0	,V	,0)	chirality -1	D*+(D+D*)
3 x	(0	,V	,V	,0	,0)	chirality 1	L+H ₁ +H ₂
2 x	(V	,0	,V*	,0	,0)	chirality -2	U*
1 x	(0	,0	,V	,V*	,0)	chirality 1	N*
4 x	(A	,0	,0	,0	,0)		U+U*
2 x	(0	,0	,0	,S	,0)		E+E*

↑
Truly hidden
hidden sector

A CURIOSITY

Gauge group $SU(3) \times SU(2) \times U(1) \times [U(2)_{\text{Hidden}}]$

U3 S2 U1 U1 U2

3 x (V ,V ,0 ,0 ,0)	chirality 3	Q
3 x (0 ,0 ,V ,V ,0)	chirality -3	E*
1 x (V ,0 ,0 ,V* ,0)	chirality -1	U*
2 x (V ,0 ,V ,0 ,0)	chirality -2	D*
2 x (0 ,V ,0 ,V ,0)	chirality 2	L
3 x (V ,0 ,0 ,V ,0)	chirality -1	D*+(D+D*)
3 x (0 ,V ,V ,0 ,0)	chirality 1	L+H ₁ +H ₂
2 x (V ,0 ,V* ,0 ,0)	chirality -2	U*
1 x (0 ,0 ,V ,V* ,0)	chirality 1	N*
4 x (A ,0 ,0 ,0 ,0)		U+U*
2 x (0 ,0 ,0 ,S ,0)		E+E*

Free-field realization with $(2)^6$ Gepner model

Holistic Wellness with Tachyons

A practical guide to the use of tachyons

Martina Bochnik & Tommy Thomsen

MATERIA TACHYON INCOGNITA



Galaxy N° 1

The First European Tachyon Products!

NON-SUPERSYMMETRIC MODELS

NON-SUPERSYMMETRIC MODELS*

Four ways of removing closed string tachyons

- Chiral algebra extension (non-susy)
- Automorphism MIPF
- Susy MIPF (non-susy extension)
- Klein Bottle

(*) *with Beatriz Gato-Rivera*

NON-SUPERSYMMETRIC MODELS*

Four ways of removing closed string tachyons

- Chiral algebra extension (non-susy) ✗
- Automorphism MIPF ✓ (44054 MIPFs)
- Susy MIPF (non-susy extension) ✓ (40261 MIPFs)
- Klein Bottle ✓ (186951 Orientifolds)

(*) *with Beatriz Gato-Rivera*

NON-SUPERSYMMETRIC MODELS*

Four ways of removing closed string tachyons

- Chiral algebra extension (non-susy) ✗
- Automorphism MIPF ✓ (44054 MIPFs)
- Susy MIPF (non-susy extension) ✓ (40261 MIPFs)
- Klein Bottle ✓ (186951 Orientifolds)

Huge number of possibilities!

(*) *with Beatriz Gato-Rivera*



NEUTRINO MASSES

NEUTRINO MASSES*

- In field theory: easy; several solutions.

Most popular:

add three right-handed neutrinos

add “natural” Dirac & Majorana masses (see-saw)

$$m_\nu = \frac{(M_D)^2}{M_M}; \quad M_D \approx 100 \text{ MeV}, \quad M_M \approx 10^{11} \dots 10^{13} \text{ GeV}$$

- In string theory: non-trivial.
(String theory is much more falsifiable!).

- Potentially anthropic.

(*) *Ibañez, Schellekens, Uranga, arXiv:0704.1079, JHEP (to appear)*
Blumenhagen, Cvetič, Weigand, hep-th/0609191
Ibañez, Uranga, hep-th/0609213

Other ideas: see e.g. Conlon, Cremades; Giedt, Kane, Langacker, Nelson;
Buchmuller, Hamaguchi, Lebedev, Ratz,

The following ingredients cannot be taken for granted in String Theory:

- Existence of a Weinberg operator.

$$\mathcal{L}_W = \frac{\lambda}{M} (L\bar{H}L\bar{H})$$

- Existence of right-handed neutrinos.
- Existence of non-zero Dirac masses.
- Absence of massless B-L vector bosons.
- Existence of Majorana masses.

NEUTRINO MASSES IN MADRID MODELS

All these models have three right-handed neutrinos (required for cubic anomaly cancellation)

In most of these models:

B-L survives as an exact gauge symmetry

Then the neutrino's can get Dirac masses, but not Majorana masses (both needed for see-saw mechanism).

In a very small* subset, B-L acquires a mass due to axion couplings.

(*) 391 out of 10000 models with $SU(3) \times Sp(2) \times U(1) \times U(1)$
(out of 211000 in total)

B-L VIOLATION BY INSTANTONS

B-L still survives as a perturbative symmetry.
It may be broken to a discrete subgroup by instantons.

RCFT instanton boundary state M :
“Matter” boundary state m , change space-time boundary conditions from Neumann to Dirichlet.

Condition for B-L violation: $I_{Ma} - I_{Ma'} - I_{Md} + I_{Md'} \neq 0$

Non-gauge (stringy, exotic) instanton:
CP multiplicity of the associated matter brane = 0

- Does not introduce new anomalies/tadpoles
- Suppression factor not related to gauge coupling strengths

$$M_M \propto M_s e^{-\frac{1}{g_M^2}}$$

INSTANTON SCAN

Can we find such branes M in the 391 models with massive B-L?

- About 30.000 “instanton branes” ($I_{Ma} - I_{Ma'} - I_{Md} + I_{Md'} \neq 0$)
- Quantized in units of 1,2 or 4
(1 may give R-parity violation, 4 means no Majorana mass)
- Some models have no RCFT instantons
- 1315 instantons with correct *chiral* intersections
- None of these models has R-parity violating instantons.
- Most instantons are symplectic in this sample.
- There are examples with exactly the right number, *non-chirally*, except for the spurious extra susy zero-modes (Sp(2) instantons).

...almost

AN $SP(2)$ INSTANTON MODEL

U3 S2 U1 U1 O

3 x (V ,V ,0 ,0 ,0)	chirality 3
3 x (V ,0 ,V ,0 ,0)	chirality -3
3 x (V ,0 ,V* ,0 ,0)	chirality -3
3 x (0 ,V ,0 ,V ,0)	chirality 3
5 x (0 ,0 ,V ,V ,0)	chirality -3
3 x (0 ,0 ,V ,V* ,0)	chirality 3
1 x (0 ,0 ,V ,0 ,V)	chirality -1
1 x (0 ,0 ,0 ,V ,V)	chirality 1
18 x (0 ,V ,V ,0 ,0)	
2 x (V ,0 ,0 ,V ,0)	
2 x (Ad, 0 ,0 ,0 ,0)	
2 x (A ,0 ,0 ,0 ,0)	
6 x (S ,0 ,0 ,0 ,0)	
14 x (0 ,A ,0 ,0 ,0)	
6 x (0 ,S ,0 ,0 ,0)	
9 x (0 ,0 ,Ad, 0 ,0)	
6 x (0 ,0 ,A ,0 ,0)	
14 x (0 ,0 ,S ,0 ,0)	
3 x (0 ,0 ,0 ,Ad, 0)	
4 x (0 ,0 ,0 ,A ,0)	
6 x (0 ,0 ,0 ,S ,0)	

AN $SP(2)$ INSTANTON MODEL

U3 S2 U1 U1 O

3 x	(V ,V ,0 ,0 ,0)	chirality 3
3 x	(V ,0 ,V ,0 ,0)	chirality -3
3 x	(V ,0 ,V* ,0 ,0)	chirality -3
3 x	(0 ,V ,0 ,V ,0)	chirality 3
5 x	(0 ,0 ,V ,V ,0)	chirality -3
3 x	(0 ,0 ,V ,V* ,0)	chirality 3
1 x	(0 ,0 ,V ,0 ,V)	chirality -1
1 x	(0 ,0 ,0 ,V ,V)	chirality 1
18 x	(0 ,V ,V ,0 ,0)	
2 x	(V ,0 ,0 ,V ,0)	
2 x	(Ad, 0 ,0 ,0 ,0)	
2 x	(A ,0 ,0 ,0 ,0)	
6 x	(S ,0 ,0 ,0 ,0)	
14 x	(0 ,A ,0 ,0 ,0)	
6 x	(0 ,S ,0 ,0 ,0)	
9 x	(0 ,0 ,Ad, 0 ,0)	
6 x	(0 ,0 ,A ,0 ,0)	
14 x	(0 ,0 ,S ,0 ,0)	
3 x	(0 ,0 ,0 ,Ad, 0)	
4 x	(0 ,0 ,0 ,A ,0)	
6 x	(0 ,0 ,0 ,S ,0)	

THE O1 INSTANTON

Type:	U	S	U	U	U	O	O	U	O	O	O	U	S	S	O	S	
Dimension	3	2	1	1	1	2	2	3	1	2	3	1	2	2	2	--	
5 x	(V , 0 , V , 0 , 0 , 0 , 0 , 0 , 0 , 0 , 0 , 0 , 0 , 0 , 0 , 0 , 0)	chirality -3															
5 x	(0 , 0 , V , V* , 0 , 0 , 0 , 0 , 0 , 0 , 0 , 0 , 0 , 0 , 0 , 0 , 0)	chirality 3															
3 x	(V , 0 , V* , 0 , 0 , 0 , 0 , 0 , 0 , 0 , 0 , 0 , 0 , 0 , 0 , 0 , 0)	chirality -3															
3 x	(0 , 0 , V , V , 0 , 0 , 0 , 0 , 0 , 0 , 0 , 0 , 0 , 0 , 0 , 0 , 0)	chirality -3															
3 x	(V , V , 0 , 0 , 0 , 0 , 0 , 0 , 0 , 0 , 0 , 0 , 0 , 0 , 0 , 0 , 0)	chirality 3															
3 x	(0 , V , 0 , V , 0 , 0 , 0 , 0 , 0 , 0 , 0 , 0 , 0 , 0 , 0 , 0 , 0)	chirality 3															
2 x	(0 , 0 , 0 , V , 0 , 0 , 0 , 0 , 0 , 0 , 0 , 0 , 0 , 0 , 0 , 0 , V)	chirality 2															
12 x	(0 , 0 , V , 0 , 0 , 0 , 0 , 0 , 0 , 0 , 0 , 0 , 0 , 0 , 0 , 0 , V)	chirality -2															
1 x	(0 , 0 , 0 , 0 , 0 , 0 , 0 , 0 , 0 , V , 0 , 0 , 0 , 0 , 0 , 0 , V)																
2 x	(0 , 0 , 0 , 0 , V , 0 , 0 , 0 , 0 , 0 , 0 , 0 , 0 , 0 , 0 , 0 , V)																
1 x	(0 , 0 , 0 , 0 , 0 , 0 , 0 , 0 , 0 , 0 , 0 , 0 , 0 , 0 , 0 , V , V)																
2 x	(0 , 0 , 0 , 0 , 0 , 0 , 0 , 0 , 0 , 0 , 0 , 0 , 0 , V , 0 , 0 , V)																
1 x	(0 , 0 , 0 , 0 , 0 , V , 0 , 0 , 0 , 0 , 0 , 0 , 0 , 0 , 0 , 0 , V)																
3 x	(0 , 0 , 0 , 0 , 0 , 0 , 0 , 0 , 0 , 0 , 0 , 0 , 0 , 0 , 0 , 0 , S)																
4 x	(0 , 0 , 0 , 0 , 0 , 0 , 0 , 0 , 0 , 0 , 0 , 0 , 0 , 0 , V , 0 , V)																
2 x	(0 , 0 , 0 , 0 , 0 , 0 , 0 , 0 , 0 , 0 , 0 , 0 , 0 , 0 , 0 , 0 , A)																
2 x	(V , 0 , 0 , 0 , 0 , 0 , 0 , 0 , 0 , 0 , 0 , 0 , 0 , 0 , 0 , 0 , V)																
3 x	(0 , 0 , 0 , 0 , S , 0 , 0 , 0 , 0 , 0 , 0 , 0 , 0 , 0 , 0 , 0 , 0)	chirality -1															
3 x	(0 , 0 , 0 , 0 , 0 , V , 0 , 0 , 0 , 0 , 0 , 0 , V , 0 , 0 , 0 , 0)	chirality 1															
1 x	(0 , 0 , 0 , 0 , A , 0 , 0 , 0 , 0 , 0 , 0 , 0 , 0 , 0 , 0 , 0 , 0)	chirality -1															
2 x	(0 , 0 , 0 , 0 , V , 0 , V , 0 , 0 , 0 , 0 , 0 , 0 , 0 , 0 , 0 , 0)	chirality 2															
1 x	(0 , 0 , 0 , 0 , 0 , 0 , 0 , V , 0 , 0 , 0 , 0 , 0 , 0 , 0 , 0 , V , 0)	chirality -1															
1 x	(0 , 0 , 0 , 0 , V , 0 , 0 , 0 , 0 , 0 , V , 0 , 0 , 0 , 0 , 0 , 0 , 0)	chirality -1															
1 x	(0 , 0 , 0 , 0 , 0 , 0 , 0 , 0 , V , 0 , 0 , V , 0 , 0 , 0 , 0 , 0 , 0)	chirality 1															
1 x	(0 , 0 , 0 , 0 , 0 , 0 , 0 , 0 , 0 , 0 , 0 , V , V , 0 , 0 , 0 , 0 , 0)	chirality -1															
1 x	(0 , 0 , 0 , 0 , 0 , 0 , V , 0 , 0 , 0 , 0 , 0 , V , 0 , 0 , 0 , 0 , 0)	chirality -1															
1 x	(0 , 0 , 0 , 0 , V , V , 0 , 0 , 0 , 0 , 0 , 0 , 0 , 0 , 0 , 0 , 0 , 0)	chirality -1															
1 x	(0 , 0 , 0 , 0 , V , 0 , 0 , 0 , 0 , 0 , 0 , 0 , V , 0 , 0 , 0 , 0 , 0)	chirality 1															
1 x	(0 , 0 , 0 , 0 , V , 0 , 0 , 0 , 0 , 0 , 0 , 0 , V* , 0 , 0 , 0 , 0 , 0)	chirality -1															
3 x	(0 , 0 , 0 , 0 , V , 0 , 0 , 0 , 0 , 0 , 0 , 0 , 0 , 0 , 0 , 0 , V , 0)	chirality 1															
1 x	(0 , 0 , 0 , 0 , 0 , 0 , 0 , V , 0 , V , 0 , 0 , 0 , 0 , 0 , 0 , 0 , 0)	chirality 1															
2 x	(0 , 0 , 0 , V , 0 , 0 , 0 , 0 , 0 , 0 , 0 , 0 , 0 , 0 , 0 , V , 0 , 0)																
1 x	(Ad , 0 , 0 , 0 , 0 , 0 , 0 , 0 , 0 , 0 , 0 , 0 , 0 , 0 , 0 , 0 , 0 , 0)																
2 x	(0 , S , 0 , 0 , 0 , 0 , 0 , 0 , 0 , 0 , 0 , 0 , 0 , 0 , 0 , 0 , 0 , 0)																
1 x	(0 , 0 , 0 , Ad , 0 , 0 , 0 , 0 , 0 , 0 , 0 , 0 , 0 , 0 , 0 , 0 , 0 , 0)																
6 x	(0 , 0 , V , 0 , 0 , 0 , 0 , 0 , 0 , 0 , 0 , 0 , 0 , 0 , V , 0 , 0 , 0)																
1 x	(0 , 0 , 0 , 0 , 0 , 0 , 0 , 0 , 0 , 0 , 0 , 0 , 0 , 0 , 0 , 0 , A , 0)																
1 x	(0 , 0 , 0 , 0 , Ad , 0 , 0 , 0 , 0 , 0 , 0 , 0 , 0 , 0 , 0 , 0 , 0 , 0)																

CONCLUSIONS

- Many desirable SM features can be realized in the RCFT orientifold landscape...

- Chiral SM spectrum
- No mirrors
- No adjoints, rank-2 tensors
- No hidden sector
- No hidden-observable massless matter
- Matter free hidden sector
- Exact $SU(3) \times SU(2) \times U(1)$
- $O1$ instantons

....but not all at the same time.

Seems just a matter of statistics.

- Neutrino masses from instantons: probably possible, but very rare in RCFT.