

Section A-A:
(Scale 4:1)

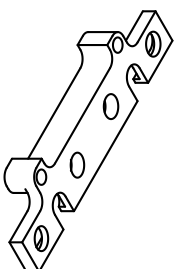

Note 1: Break sharp edges, except the indicated edges (See note 2)
Note 2: Leave this edges sharp

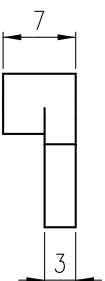
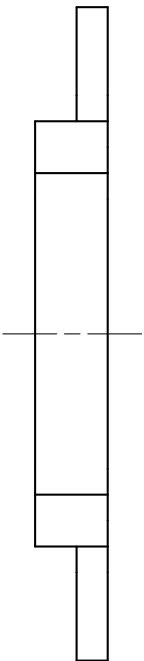
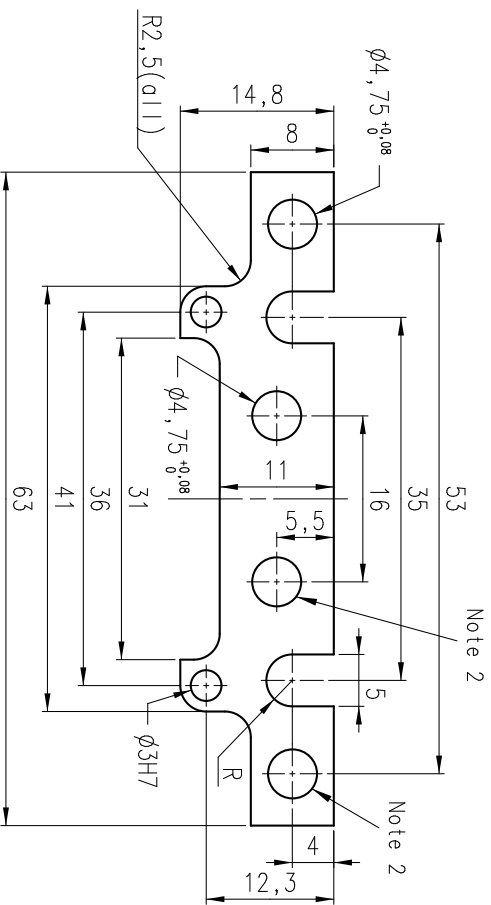
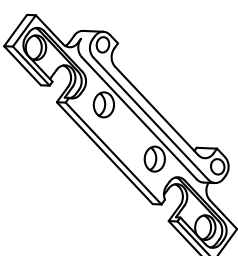
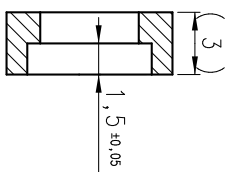
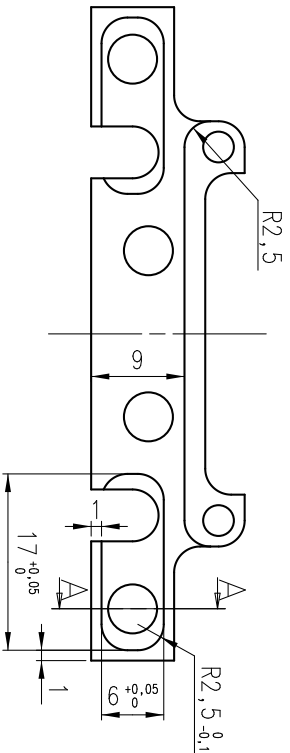

PART NO.	NUM-BER	TITLE	MATERIAL	AA-5083
Project:		TCGS - Tracker Thermal Control System		
Title:		P15 Thermal Bridge Bracket		
Th. Bar #		#3-13		
Scale:	2:1	Drawn:	B. Verlaot	
Date:	2-6-2004	Dim.:	in mm	
National Institute for Nuclear Physics, AND HIGH ENERGY PHYSICS P.O. 41882, 1009 DB Amsterdam, The Netherlands Visitors: Kruislaan 409, 1098 SJ Amsterdam tel.: +31-(0)20-5922095 fax: +31-(0)20-5925155		Size	Identification No.:	
General tolerances unless otherwise stated according to ISO-2768-FH-E		Geometrical tolerances unless otherwise stated according to ISO-8015-E	Roughness unless otherwise stated according to ISO 1302	
Sheet No: 1		Number of sheets: 1		

