

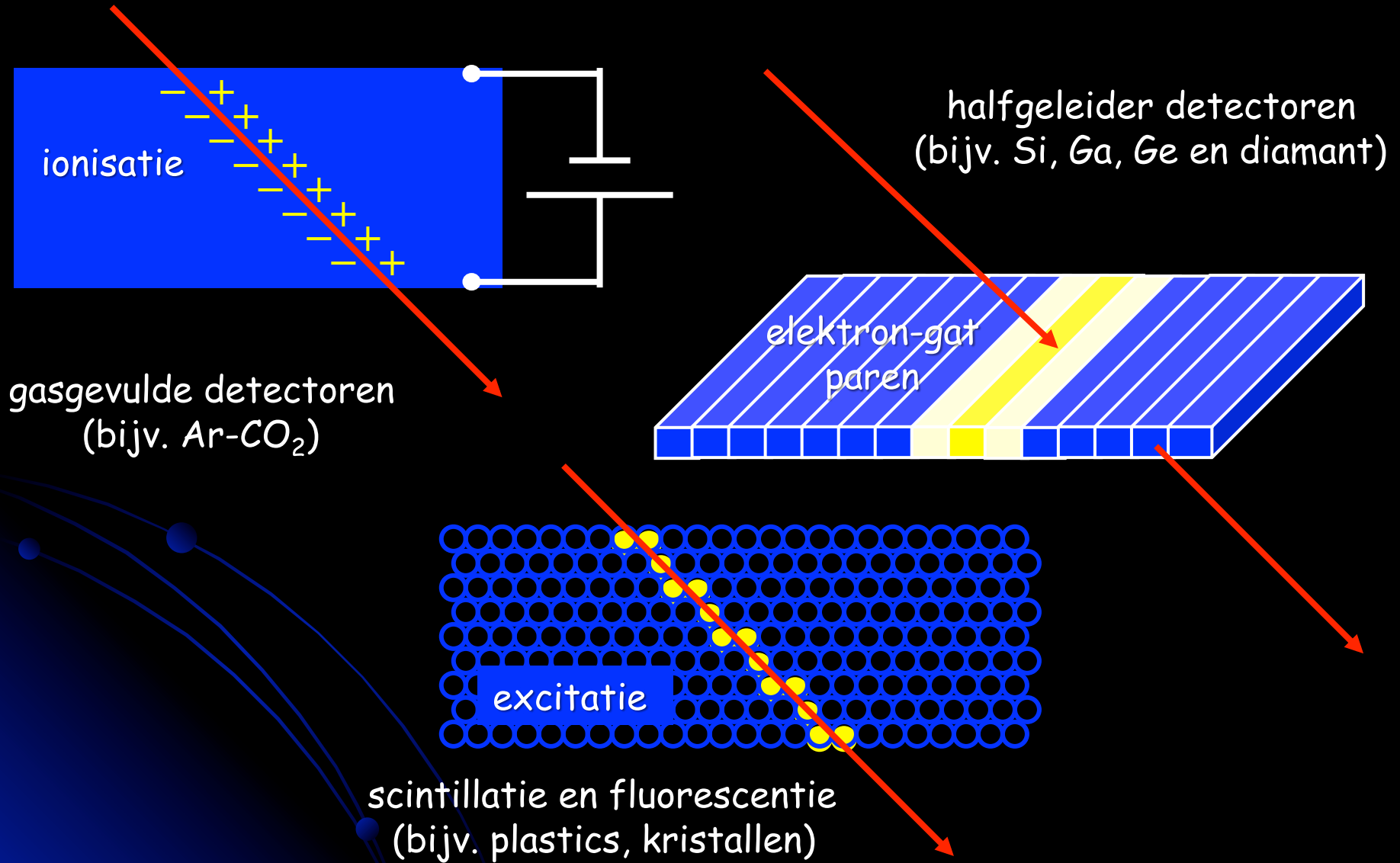

Nieuwe Grenzen:
de
'Large Hadron Collider'
(II)

Geladen deeltjes detecteren



"Drift" detectoren

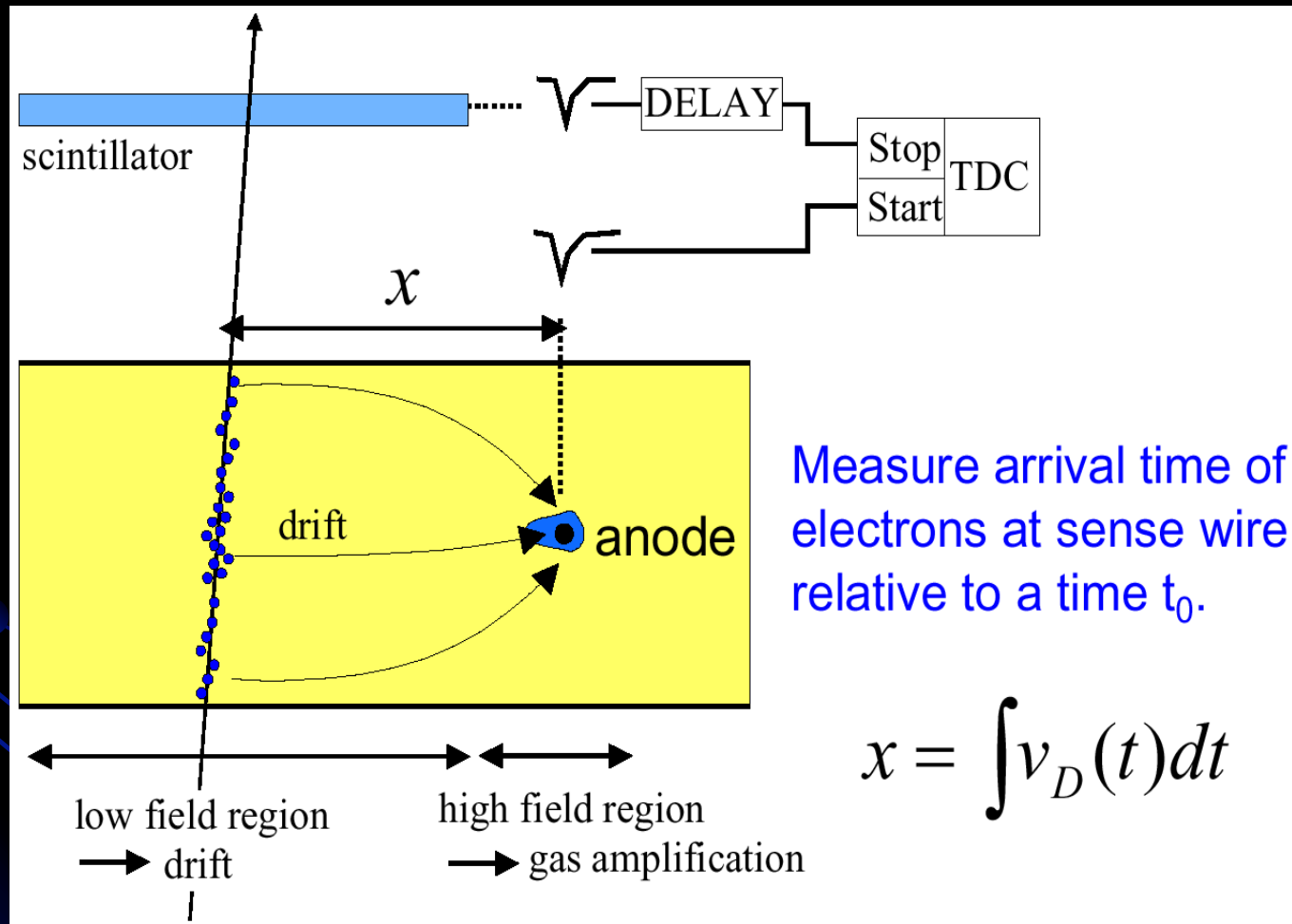

Diverse cilindrische drift kamers

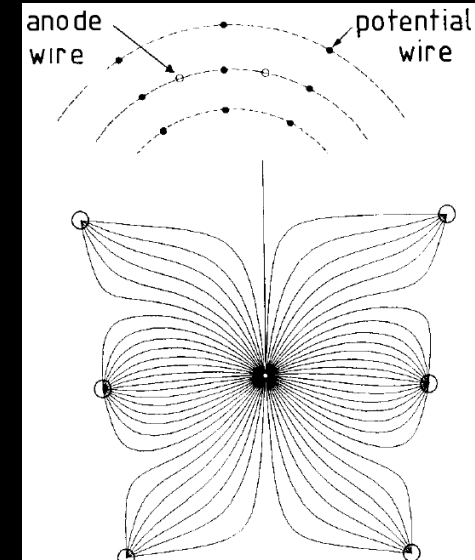
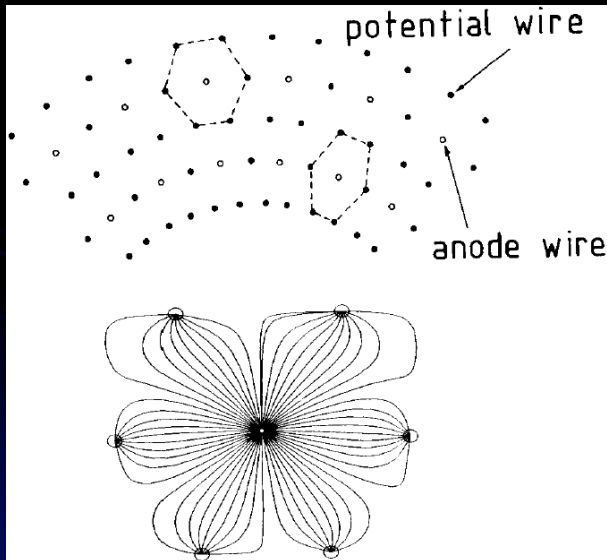
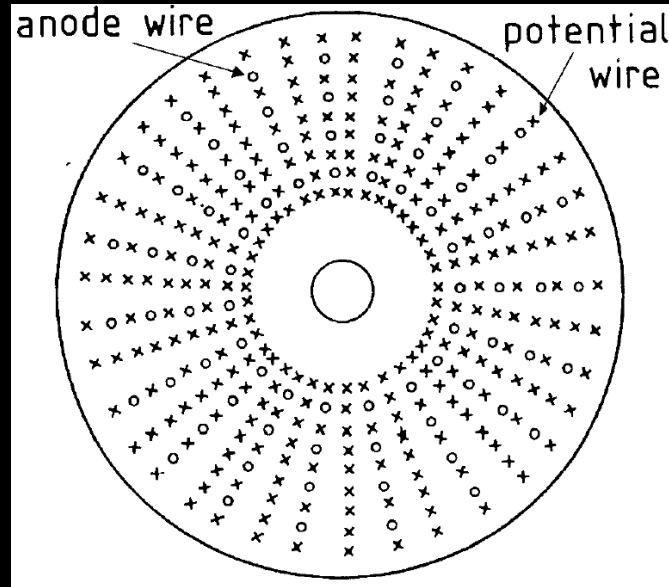

Positionering anode- en kathode-draden definieert vorm elektrisch veld

Een moderne dradenkamer

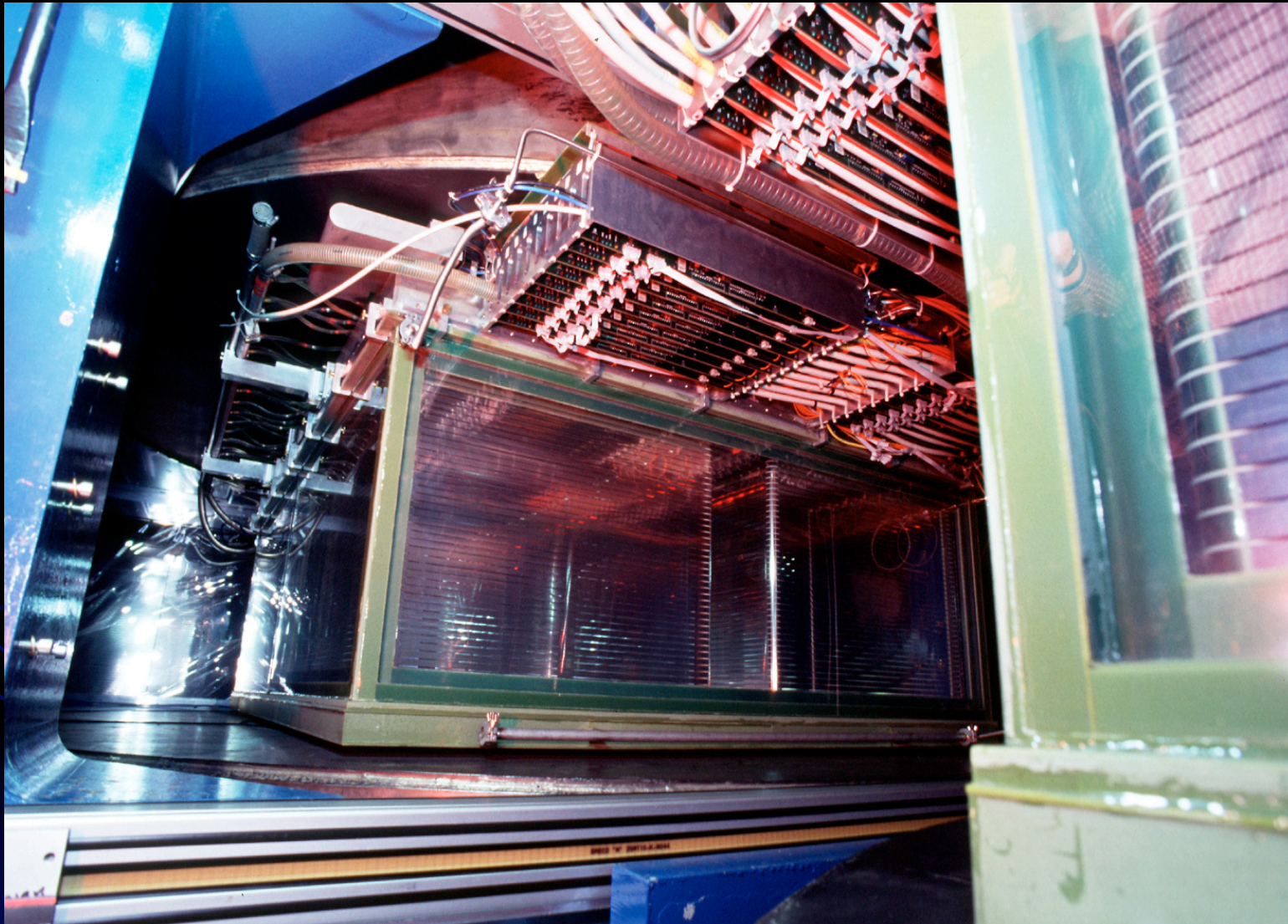

NA49 experiment (maart 2000)

"Strootjes detector"

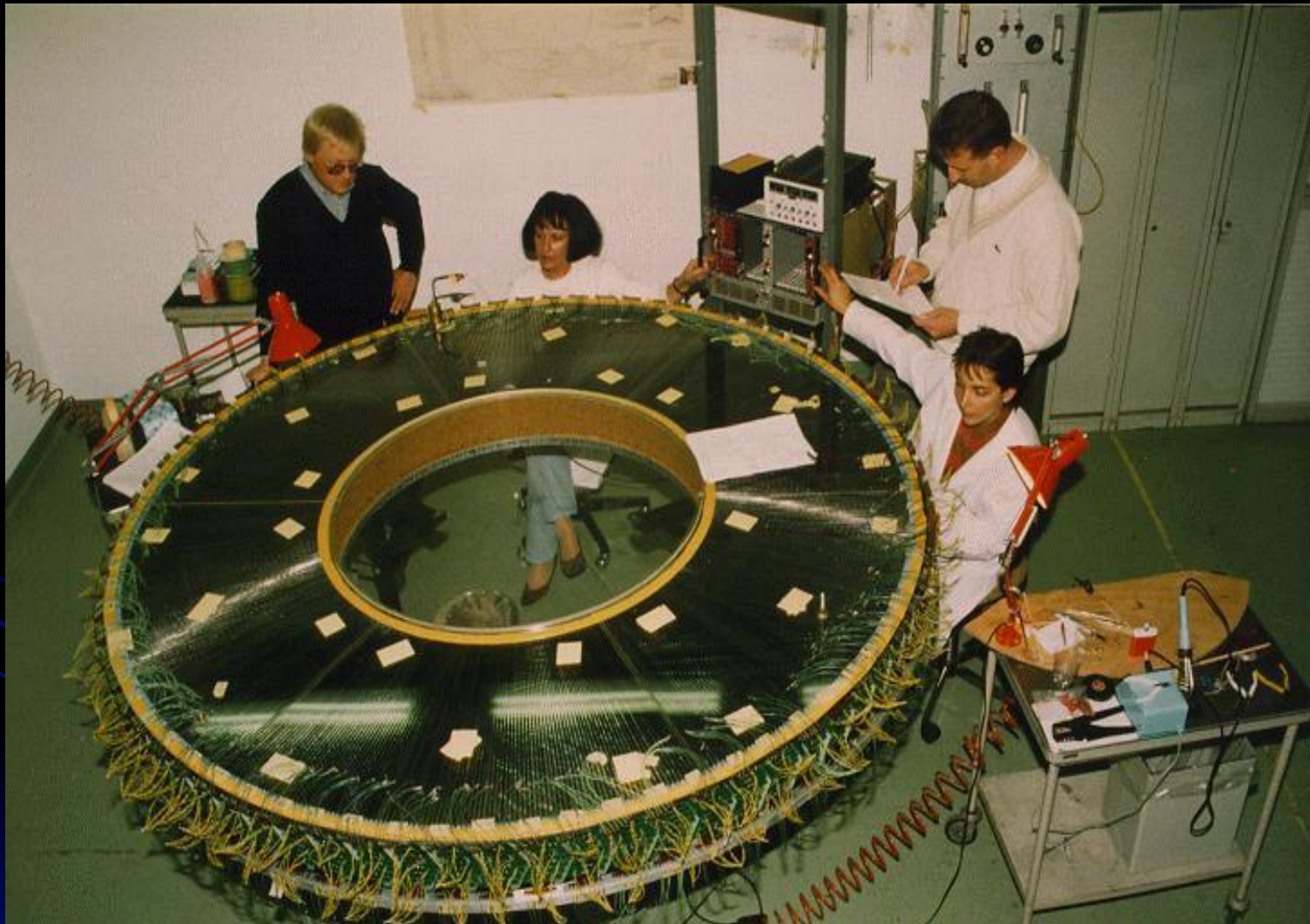

Vaste stof detectoren

- Vaste stof (Si, Ge, GeLi) detectoren hebben een lange traditie bij het meten van energie
- Vaste stof detectoren (Si, GaAs etc.) vinden brede toepassing bij het meten van de positie van geladen deeltjes en tellen van fotonen
- Silicon eigenschappen:
 - energie nodig voor vormen elektron-gat paar ~ 3.6 eV (in gas detector ~ 30 eV)
 - hoge materiaaldichtheid (2.33 g/cm³); een geladen deeltje laat ~ 390 eV/ μ m achter, genoeg om ~ 108 elektron-gat paren te genereren !
 - zowel elektronen als gaten zijn zeer mobiel ($m_e = 1450$ cm²/Vs, $m_{\text{gat}} = 450$ cm²/Vs)
 - productie van detectoren vergelijkbaar met de productie van micro-elektronica (kleine structuren en snelle ladingverzameling, < 10 ns)
 - detectoren zijn rigide (typische dikte ~ 300 μ m $\rightarrow \sim 3.2 \times 10^4$ elektron-gat paren) en stabiel. Echter, geen ladingvermenigvuldiging !

Silicon detectoren

- In pure silicon (geen doping !) is de elektronen dichtheid n , gelijk aan de gatendichtheid p : $n = p = n_i \sim 1.45 \times 10^{10} / \text{cm}^3$

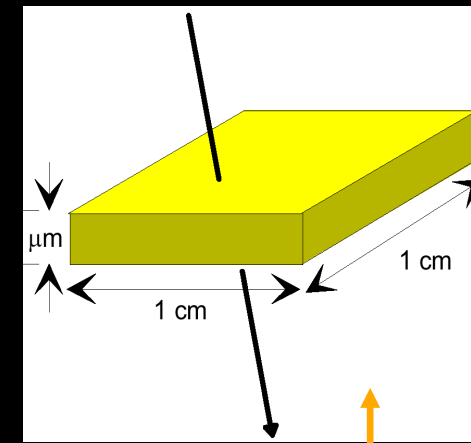
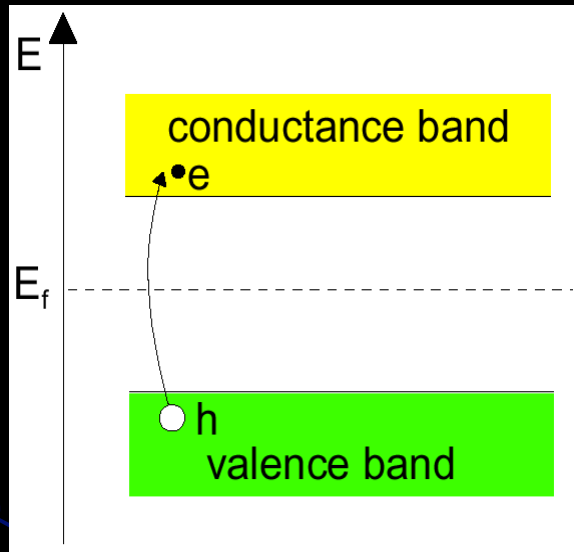

- Praktijk: geladen deeltje produceert in een volume van $1 \text{ cm} \times 1 \text{ cm} \times 300 \mu\text{m}$ ongeveer 3.2×10^4 elektron - gat paren
- Signaal is veel kleiner dan de achtergrond!

"Doping" van silicon detectoren

- Pas doping toe:

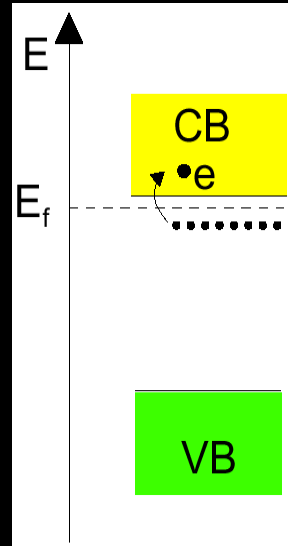

n-type silicon:
doping met elementen uit groep V
zoals As.
Elektronen vormen de
meerderheid van de ladingdragers

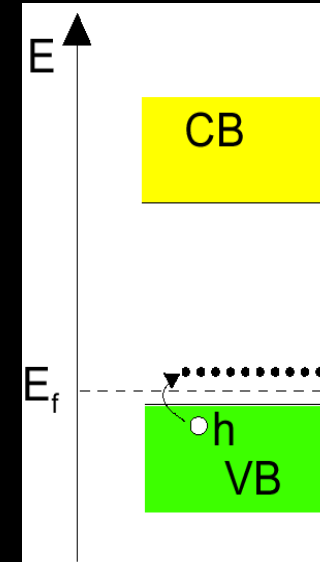

p-type silicon:
doping met elementen uit groep III
zoals B.
Gaten vormen de meerderheid van
de ladingdragers

doping concentratie:

el. weerstand:

Detector:

$10^{12}/\text{cm}^3$ (n)

$10^{15}/\text{cm}^3$ (p)

$\sim 5 \text{ k}\Omega\text{cm}$

Elektronica:

$10^{17(18)}/\text{cm}^3$

$\sim 1\Omega\text{cm}$

p-n overgang...

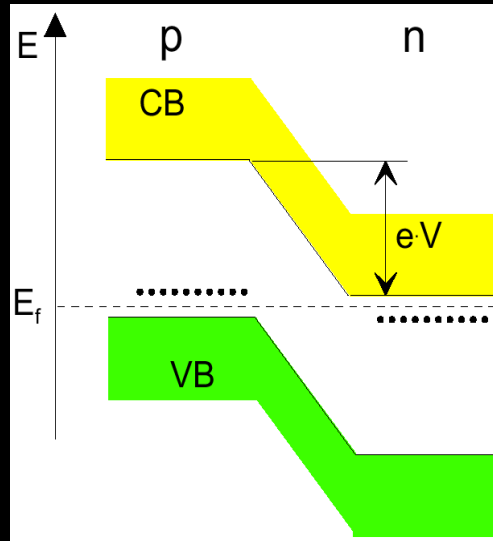

- Op een p-n moet een stabiele toestand bestaan (een enkel Fermi-niveau)
- Daardoor ontstaat een vervorming van de bandenstructuur
- Er ontstaat dus een potentiaalverschil

Silicon "verarming" (depletion)

Gebied rond p-n overgang is verarmd (geen vrije ladingdragers)

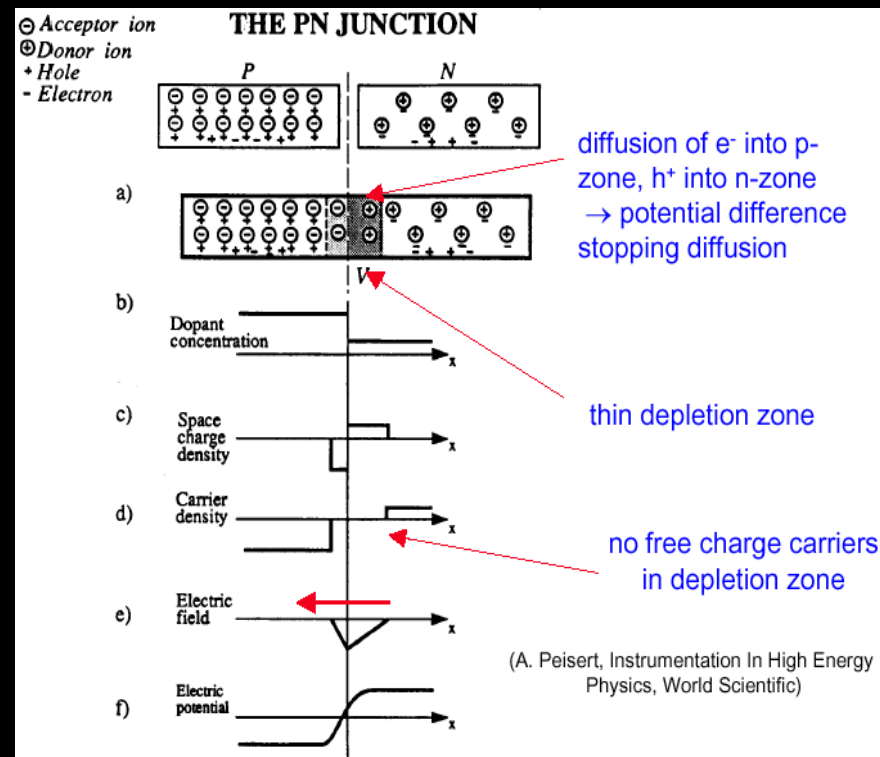

- Leg een (grote ~ 100 V) "omgekeerde" bias-spanning aan zodat het gebied zonder vrije ladingdragers uitgebreid wordt
- Energy depositie in deze zone genereert elektron-gat paren
- Elektrisch veld: elektronen drijven naar de n-zijde, gaten naar de p-kant

Halfgeleider strip detector

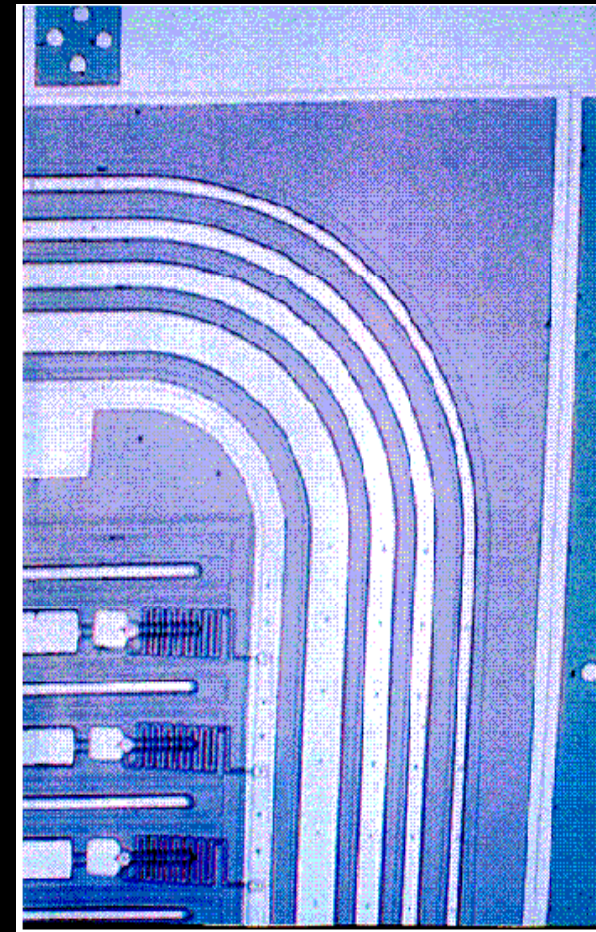
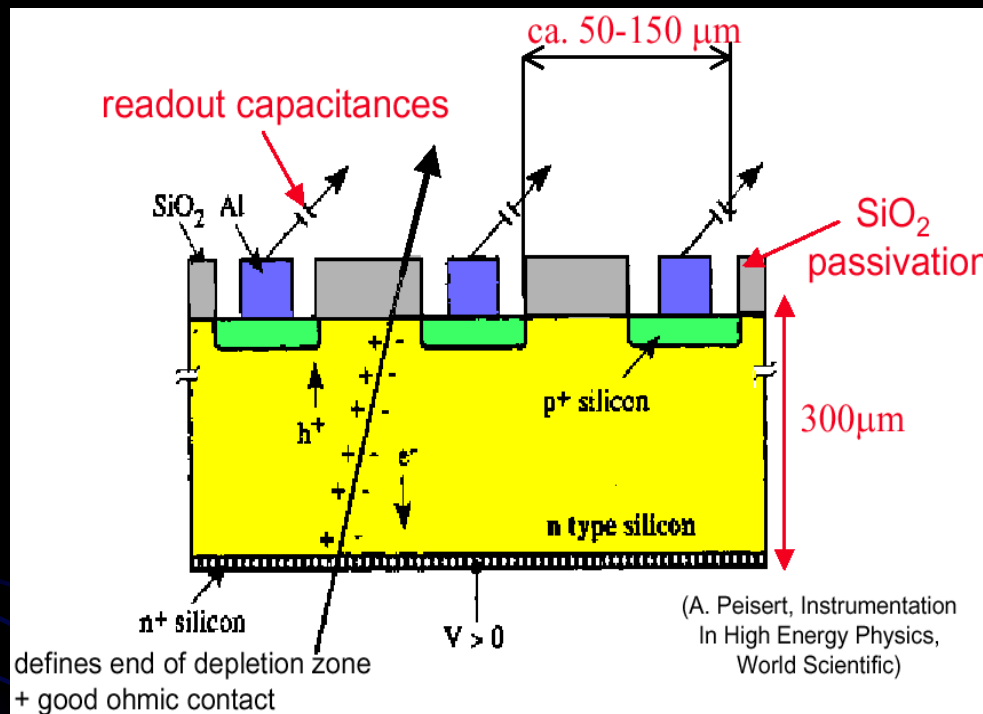

- "Slimme" doping: implanteer lokale n/p doping in "bulk" p/n materiaal (fig. links)
- Leg metaal laag (strip) aan op deze lokaal gedoopte gebieden (rechts)
- Afstand tussen strip orde 100 μm

ALEPH silicon micro-strip detector (Dec. 1998)

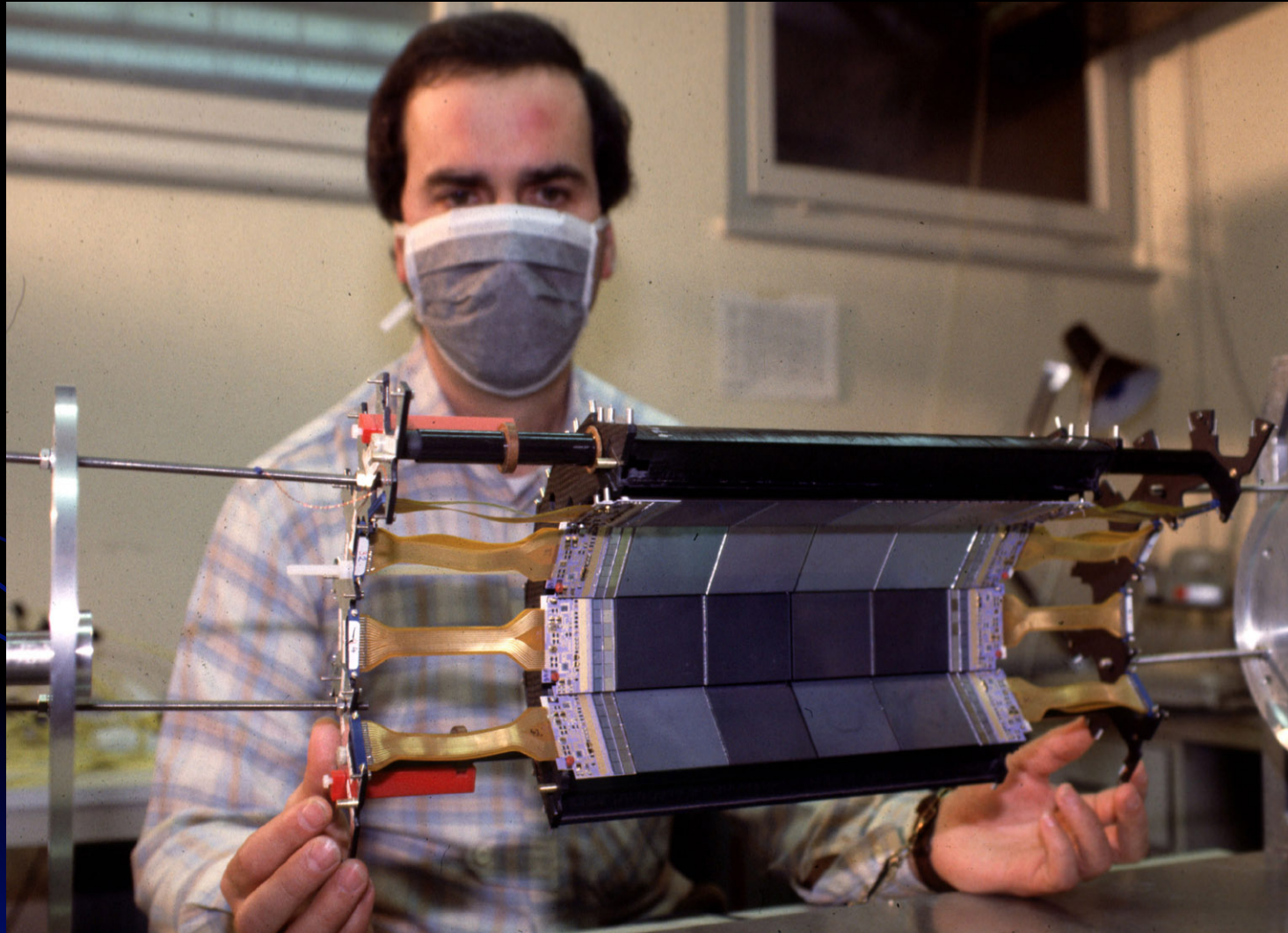

Silicon pixel detector

In plaats van strips, pixels !

Elektronische signalen aan de onderzijde uitvoeren: "flip-chip" technologie

Detector

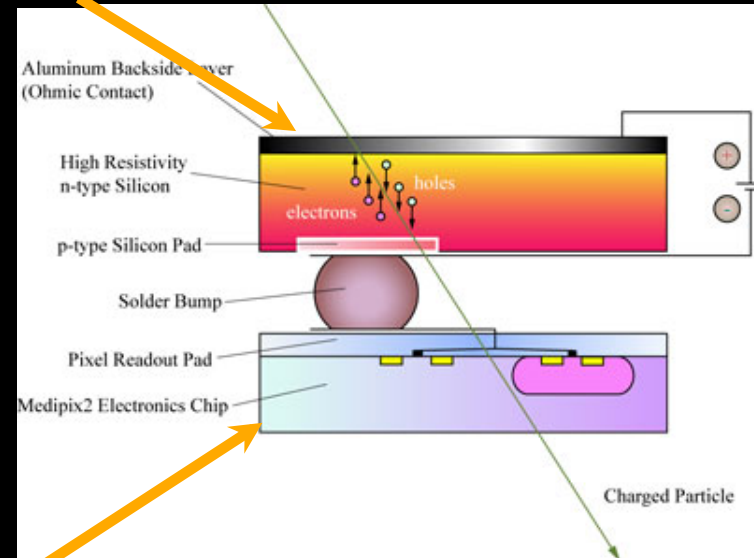
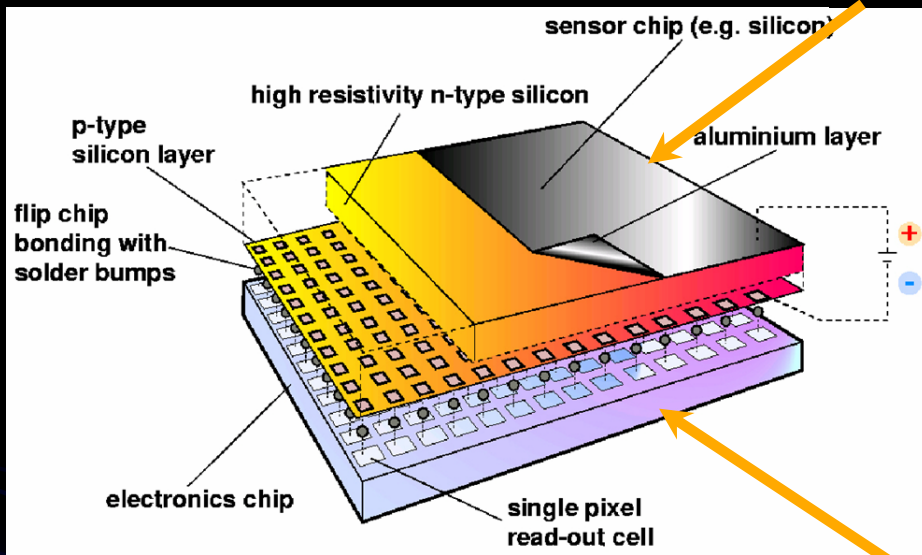

Elektronica uitlees chip

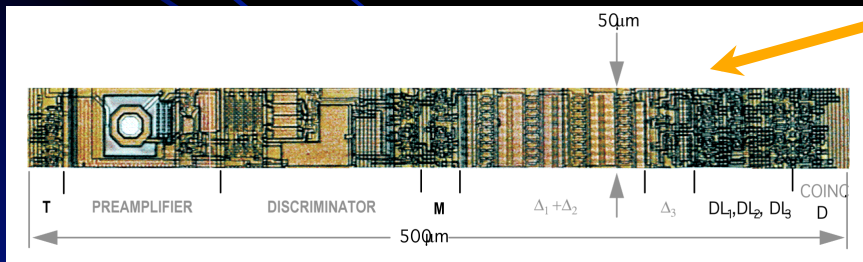

Uitlees-frequentie: 40 MHz !

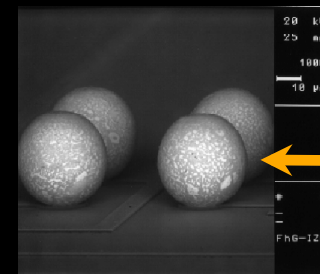

"Bump-bonding"

Silicon detector "wavers"

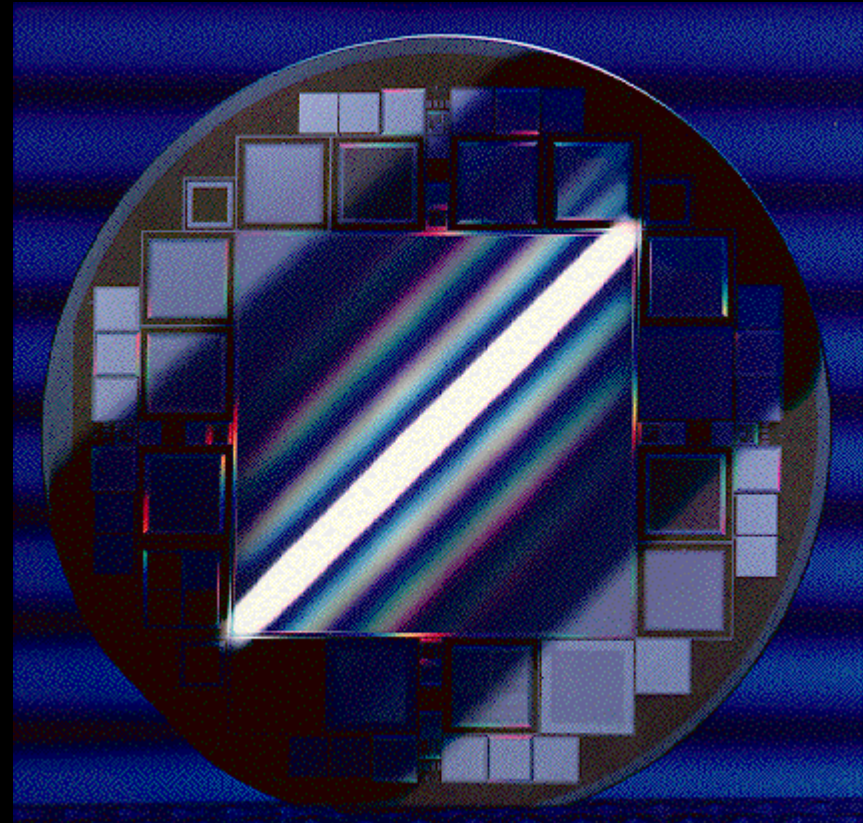
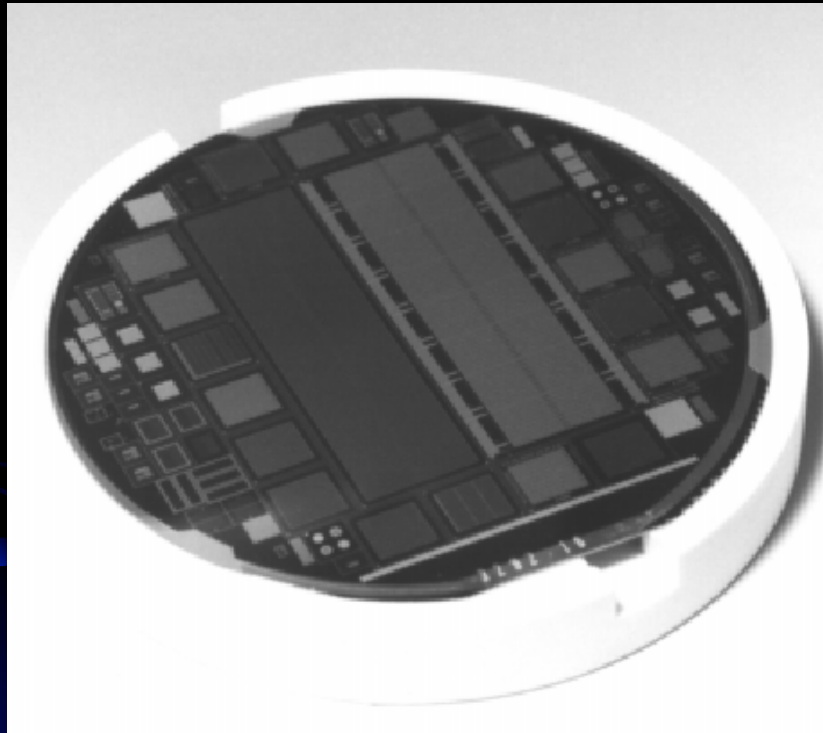

4", 5", 6", ...



MWPC MSGC "Solid State"

- Gasgevulde detectoren:

MWPC

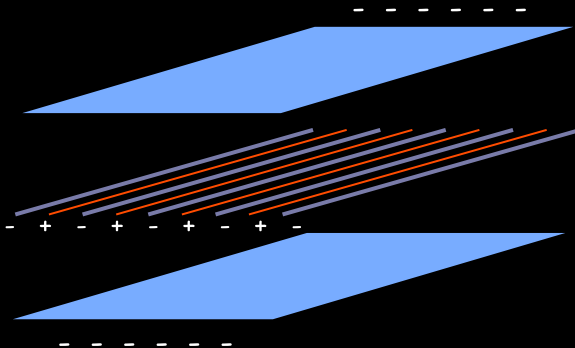

MSGC

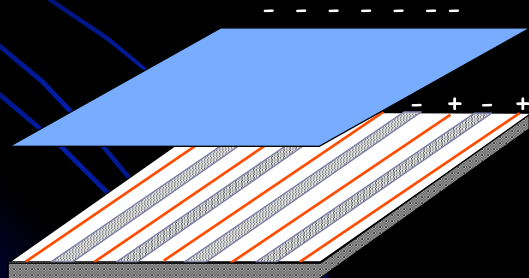

- Vaste stof detectoren:

Silicon

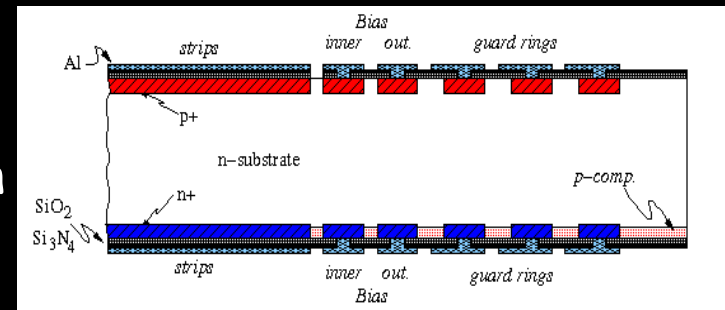

Diamant

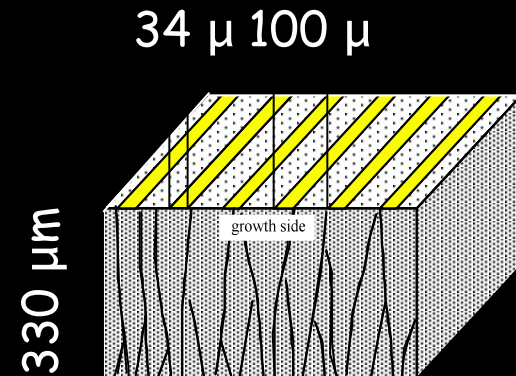

Schone botsingen met elektron- en positronbundels maar...

- Bundelenergie wordt beperkt door synchrotron-verliezen (straling):

$$\frac{\Delta E_{elektron}}{\Delta E_{proton}} = \left(\frac{m_p}{m_e} \right)^4 \approx 10^{13}$$

- Minder synchrotronstraling betekent economischer naar hogere energieën...
- Dus beter: waterstof-kernen versnellen !

...proton heeft substructuur...

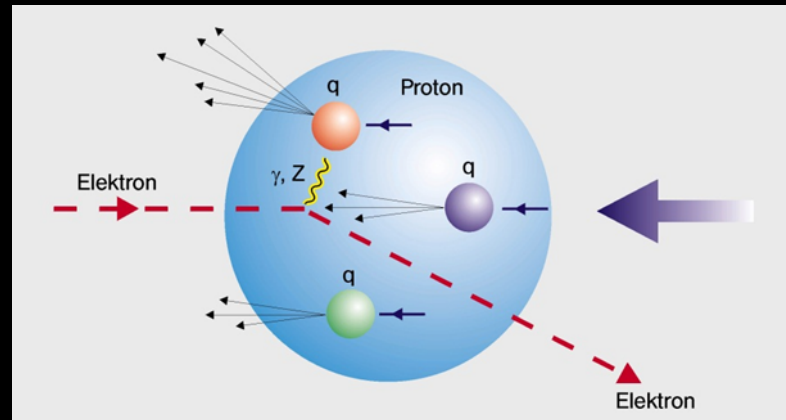

- Elektron en proton botsen elastisch (lage energie: golflengte van het foton is groot !):
- Het elektron "ziet" het proton als een massieve geladen bol

of

- Elektron en proton botsen inelastisch (hoge energie: golflengte van het foton is klein !):
- Het elektron penetreert de bol en "ziet" geladen puntdeeltjes (quarks)

... "chaos" in het proton...

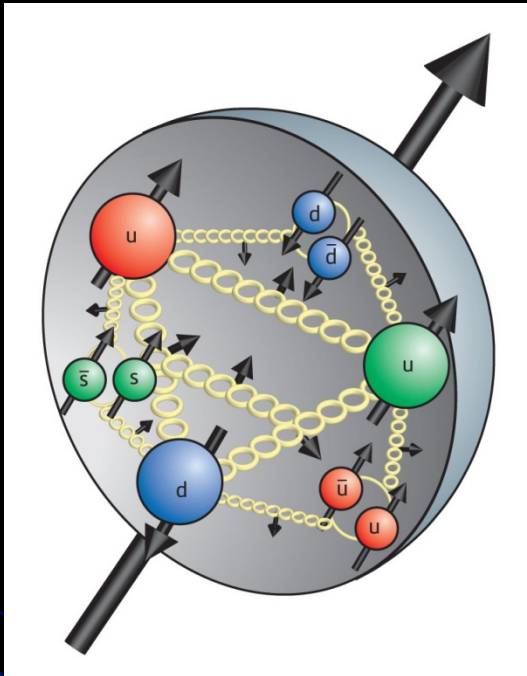

proton

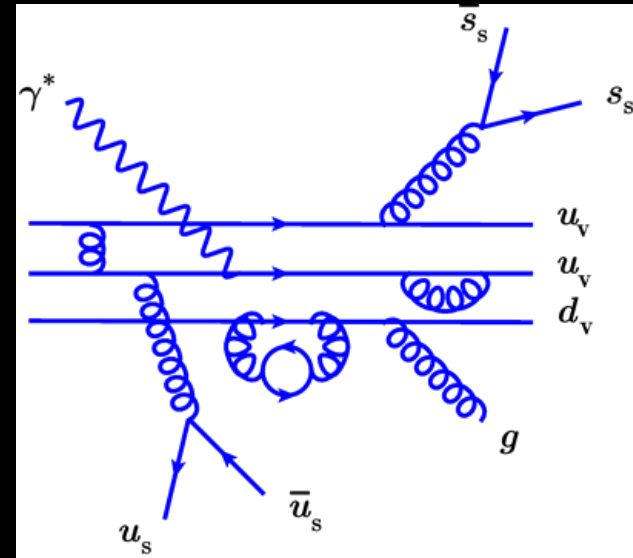

- Niet alleen diverse quarks in het proton...
- ...maar ook antiquarks en...
- ...gluonen !

De kans om een bepaald type quark of een gluon aan te treffen in een proton is afhankelijk van de fractie (x) van de protonenergie die het quark/gluon bezit:

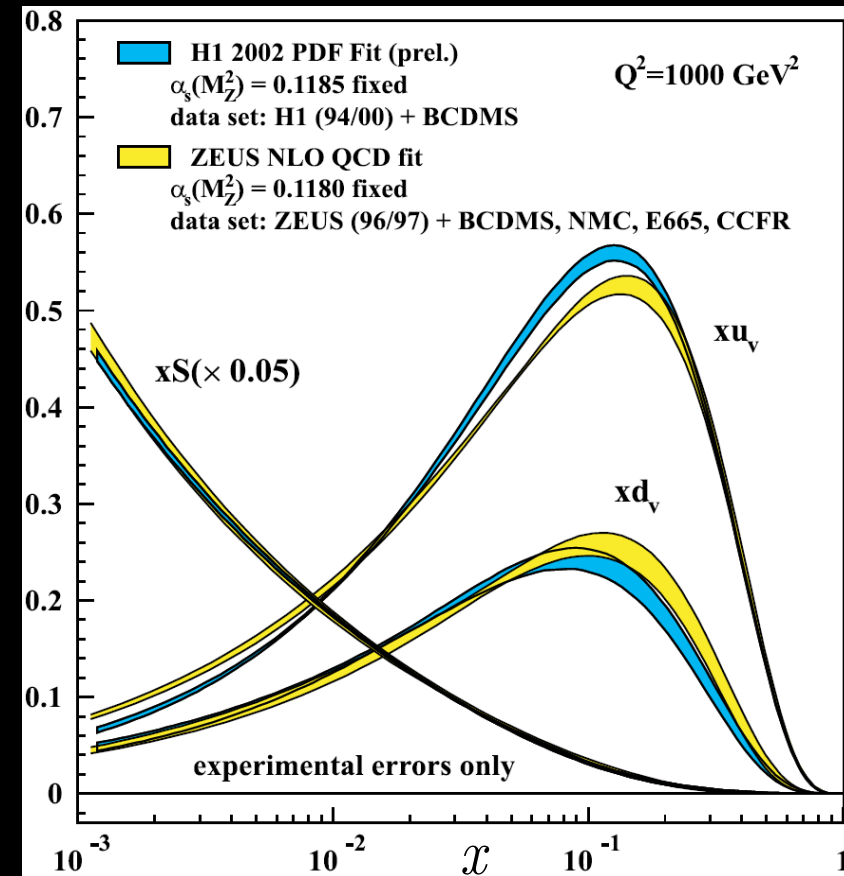
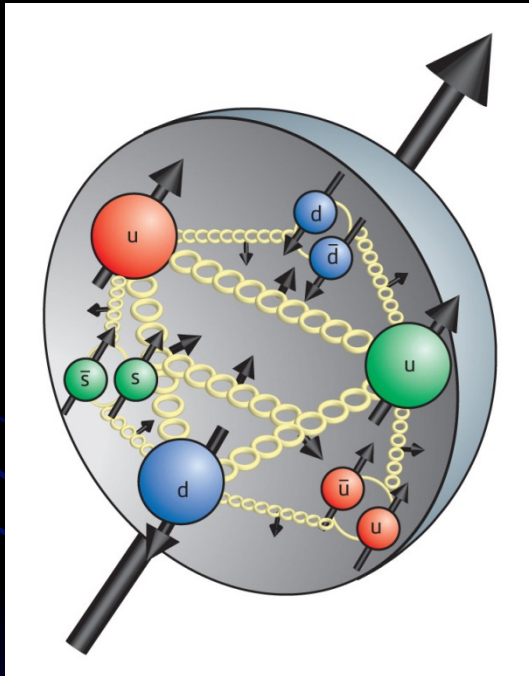

Elektron-proton botsingen echter minder "schoon" dan elektron-positron botsingen:

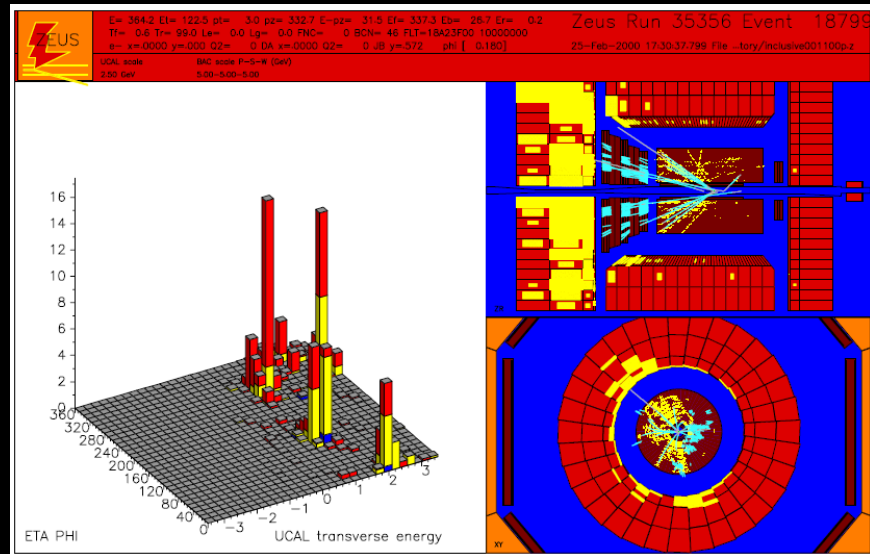
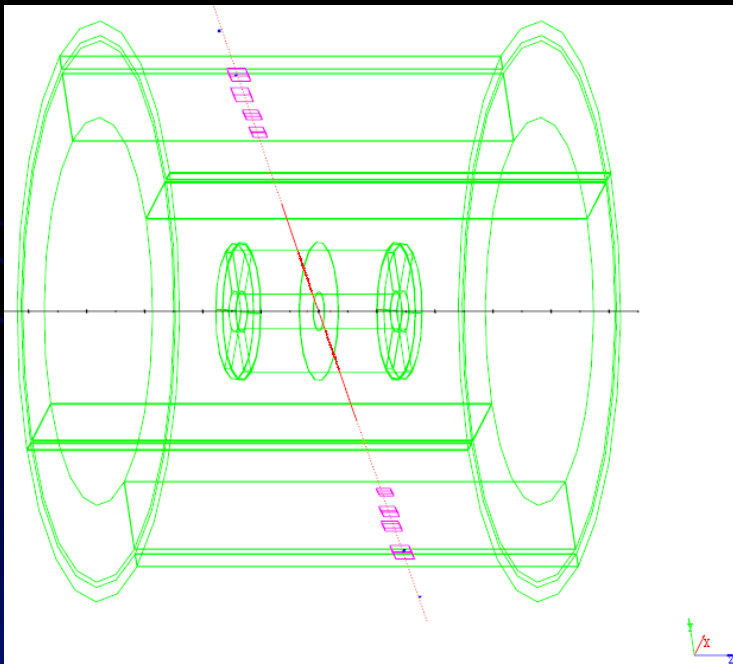
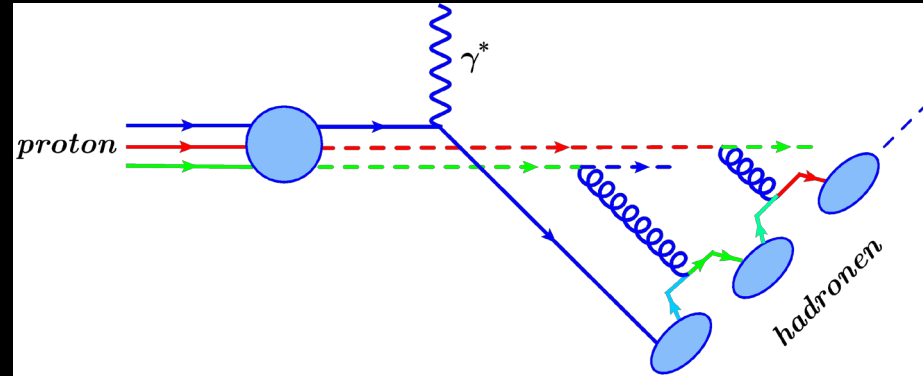
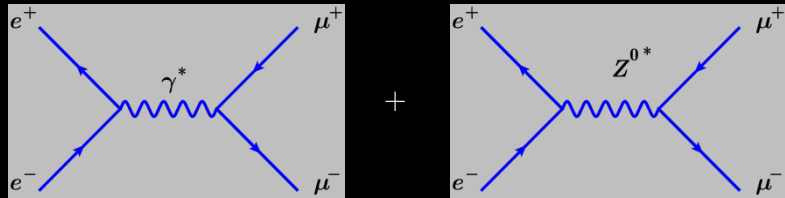

's Werelds krachtigste microscoop; de **L**arge **H**adron **C**ollider (**LHC**)

- protonen op protonen schieten
- protonen versnellen naar 7,000,000,000,000 eV

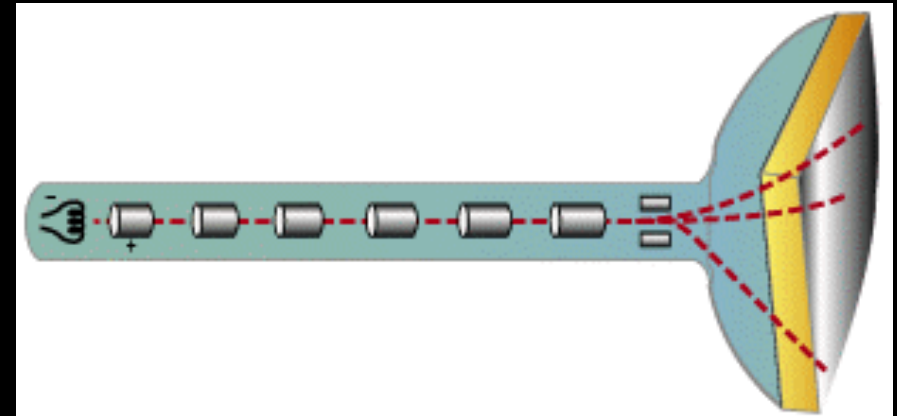
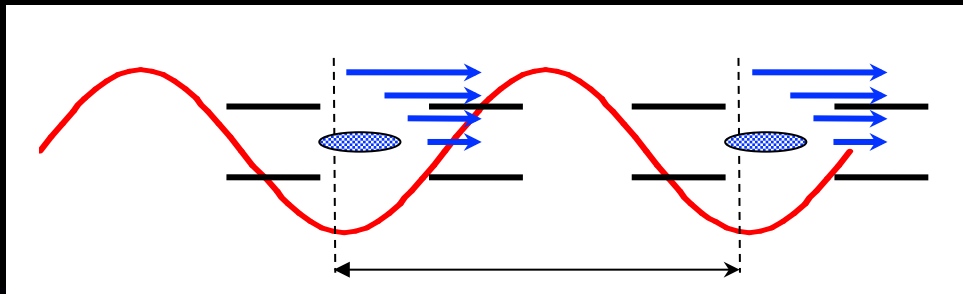

(Ouderwetse) televisie: 40,000 eV (elektronen) !

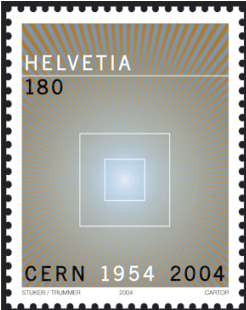

De "Large Hadron Collider"

proton-proton botsingen bij 14 TeV

CMS

26.7 km omtrek

ALICE

Eerste bundels: 2008

ATLAS

LHCb

Eerste botsingen: 2009

The Large hadron collider

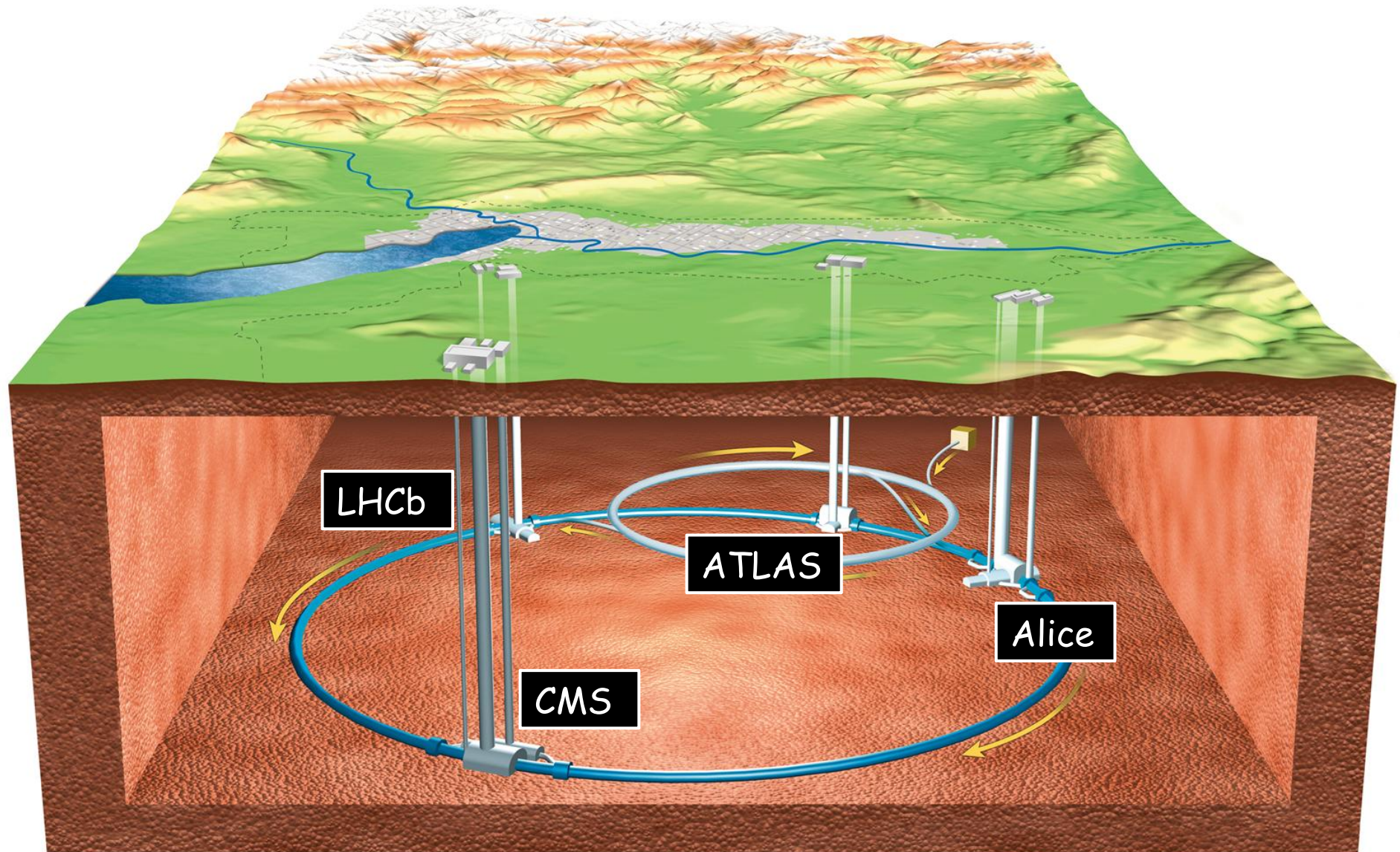

Versnellers bij CERN

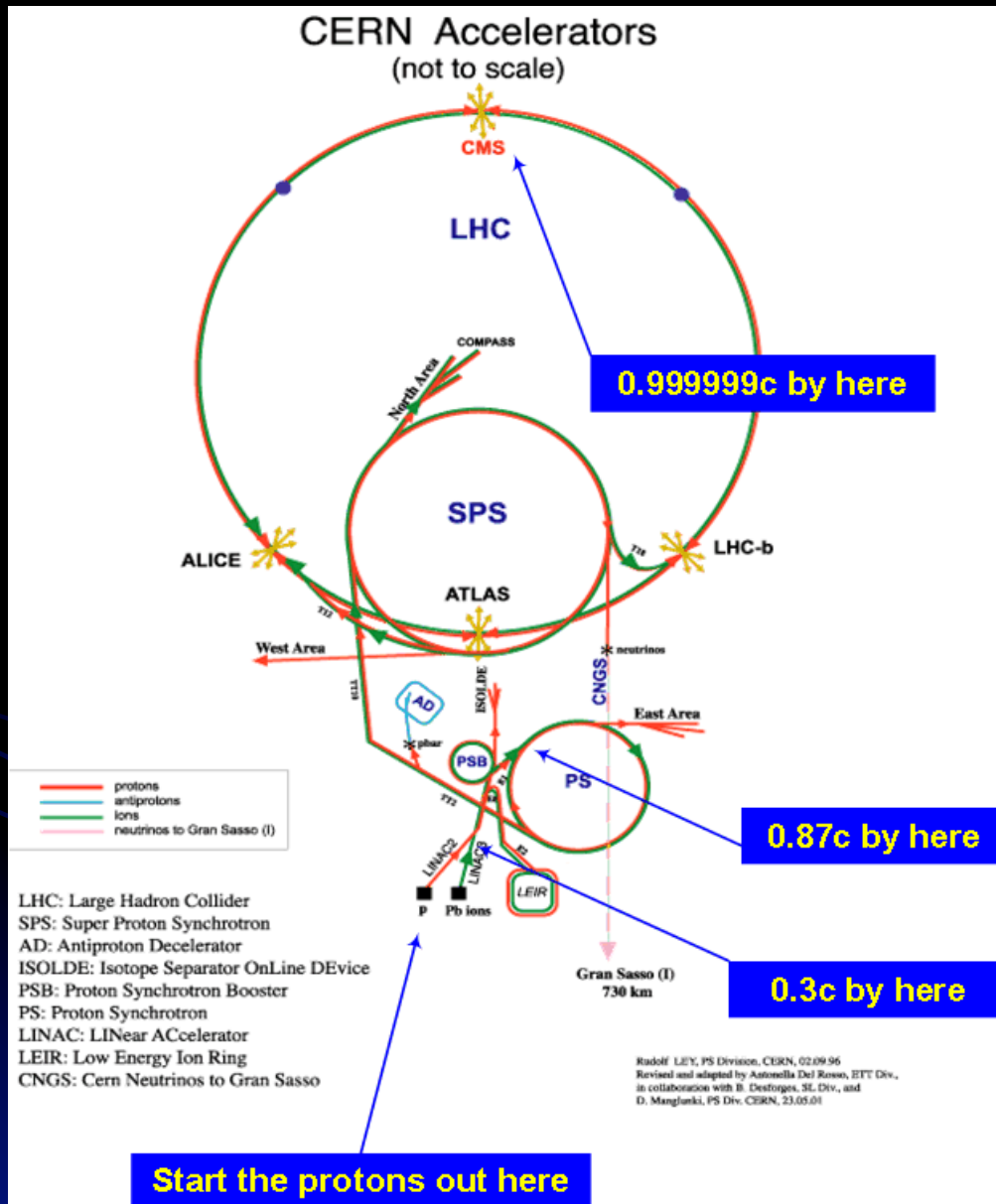

Proton energie:

Linac: 50 MeV

PSB: 1.4 GeV

PS: 28 GeV

SPS: 450 GeV

LHC: 7 TeV

In tegenstelling tot de situatie bij LEP, bezitten de deeltjes nu in beide bundels dezelfde lading! De 15 m lange supergeleidende ~ 9 Tesla dipool magneet met een dubbele boring kan beide bundels in hun baan houden.

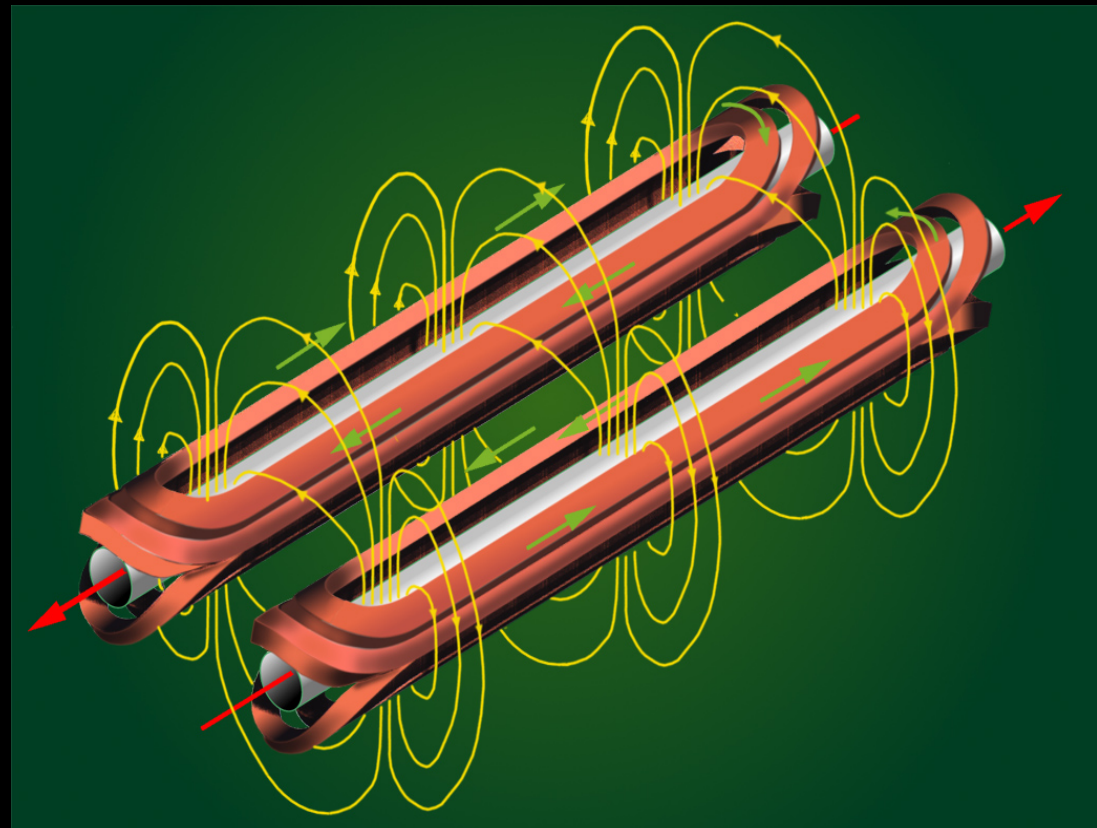
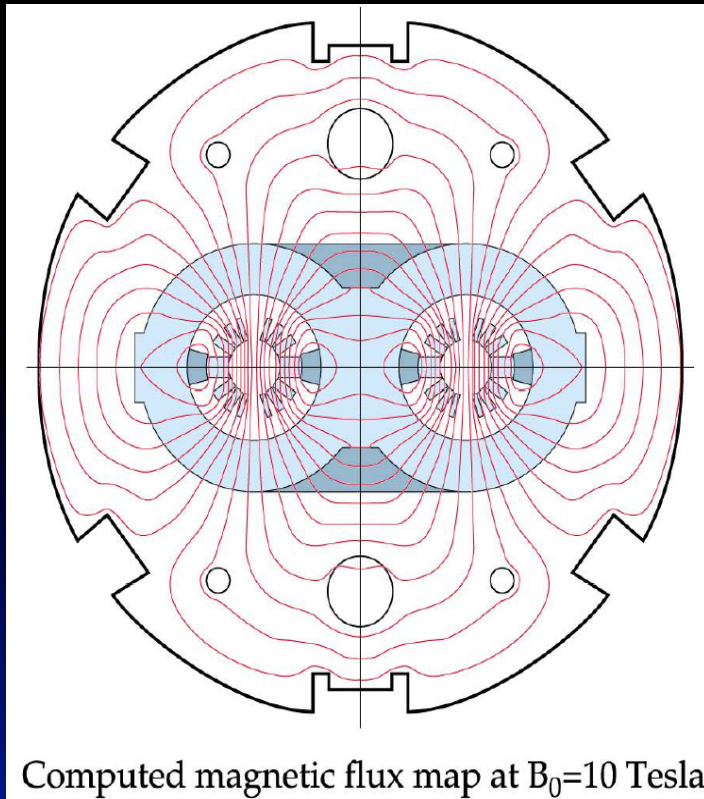

Supergeleidende magneten



Bij een temperatuur van 1.9 K ... de koudste plek in het universum...!

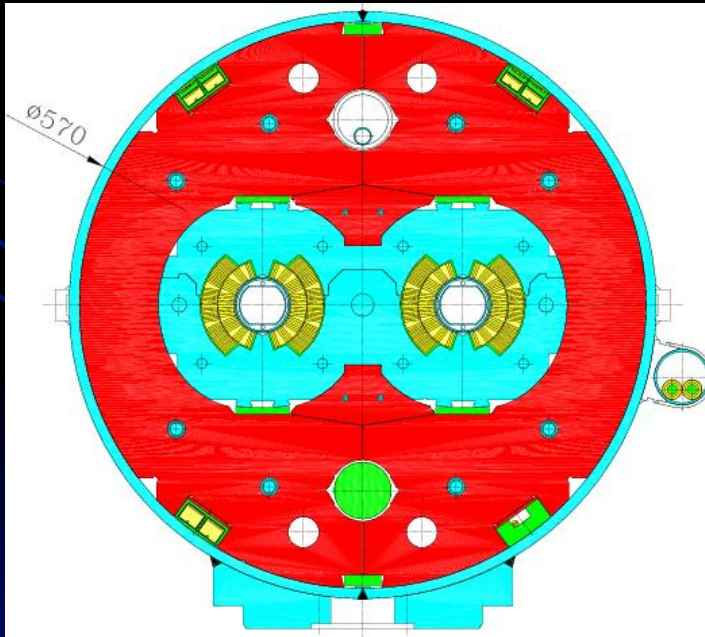

15 m lange dipool magneten

Supergeleidende niobium versnellersecties

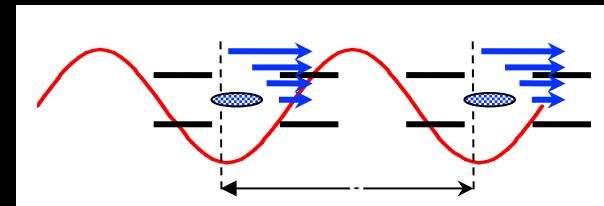
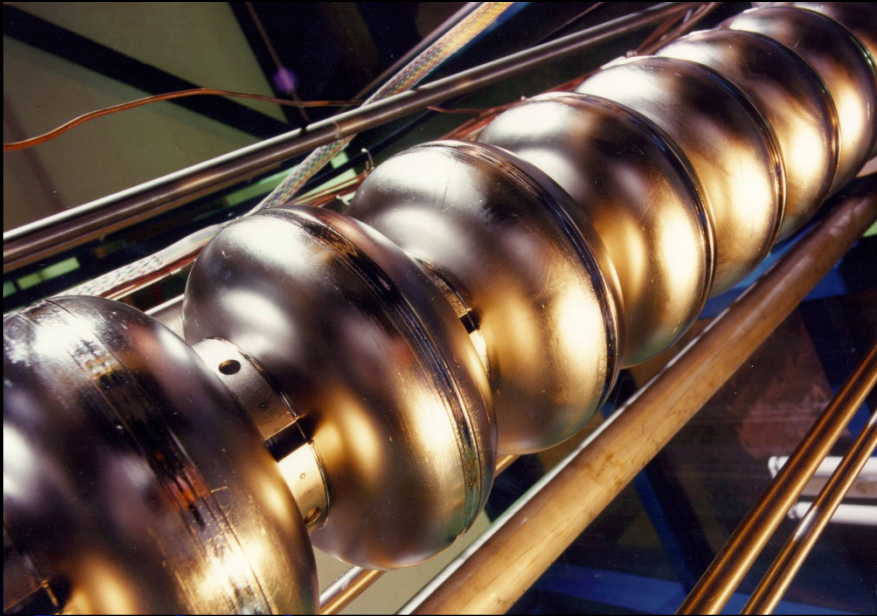

- Gradiënt: 30 MVolt/m

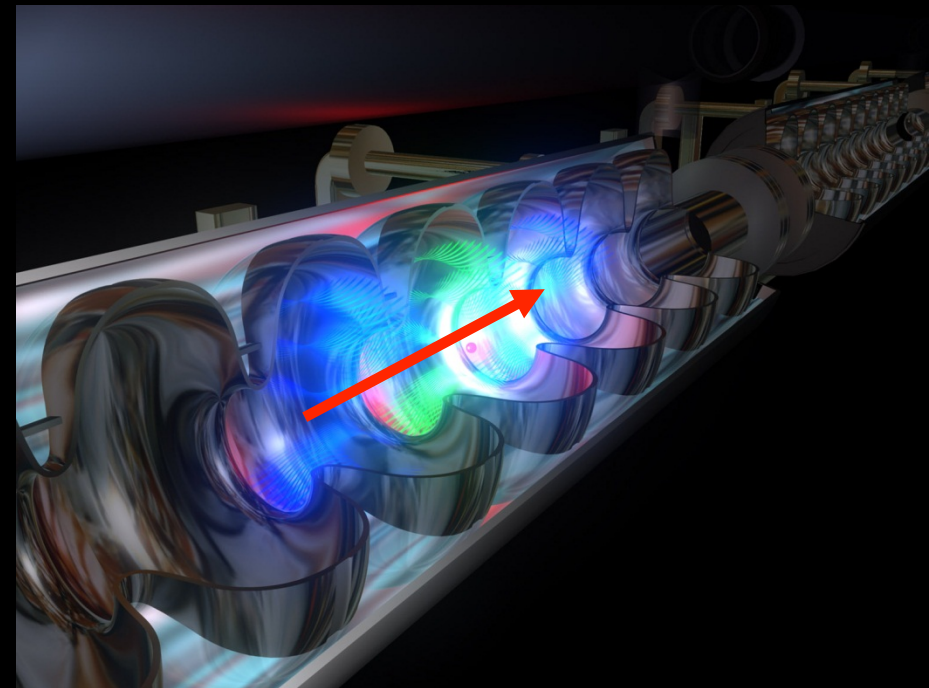

- Extreem vacuüm: 10^{-10} Torr
(~3 miljoen moleculen/cm³)

LHC leverde in 2011...

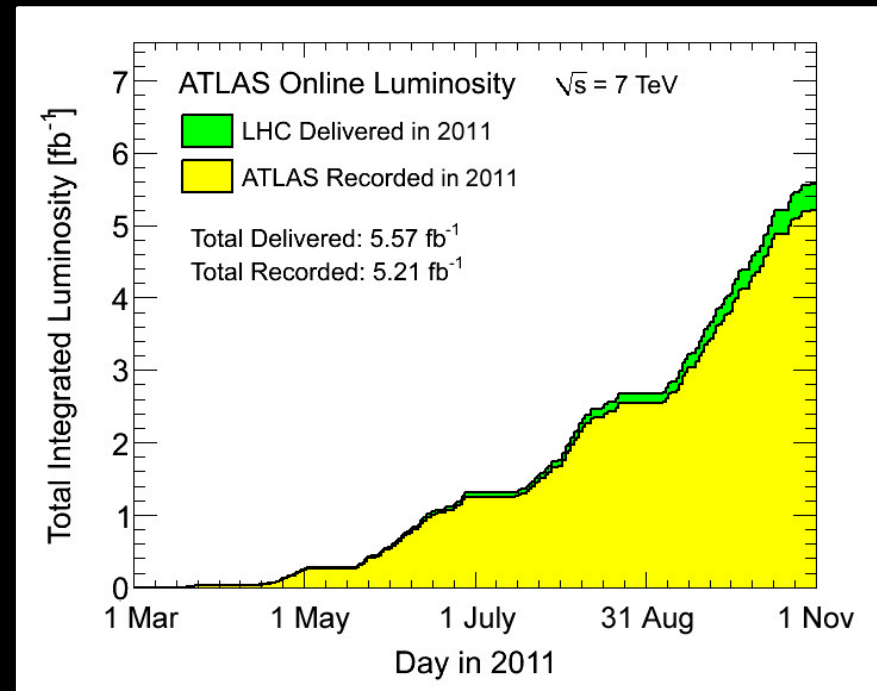
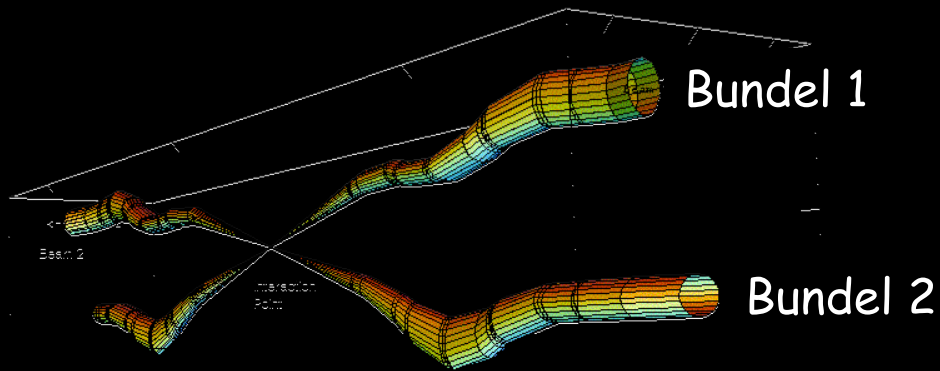

$$N = L \times \sigma$$

$$\left[\text{sec}^{-1} \right] = \left[\text{cm}^{-2} \text{sec}^{-1} \right] \times \left[\text{cm}^2 \right]$$

- 40 miljoen botsingen per seconde
- 200 botsingen/seconde worden geselecteerd!
- Piek luminositeit = $3.65 \times 10^{33} \text{ cm}^{-2} \text{ s}^{-1}$

ATLAS: "General purpose" experiment

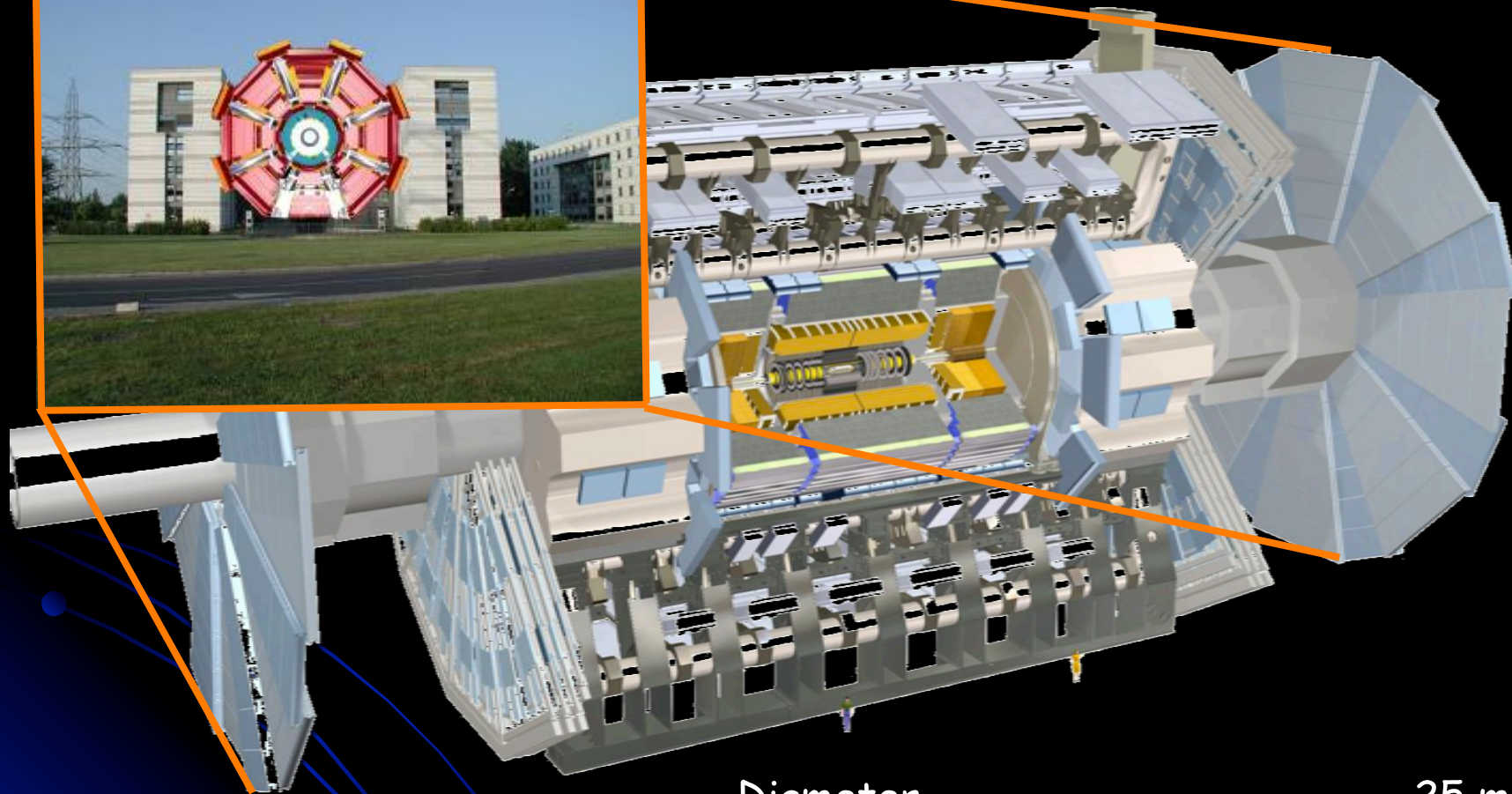

Diameter	25 m
Cilinder-toroïde lengte	26 m
Eind-plug afstand buitenzijden	46 m
Totaal gewicht	7000 ton

ATLAS...eerste constructies...





Installatie (augustus 2005) van de laatste van
8 supergeleidende 25 m lange toroides

...2 Tesla supergeleidende toroides...

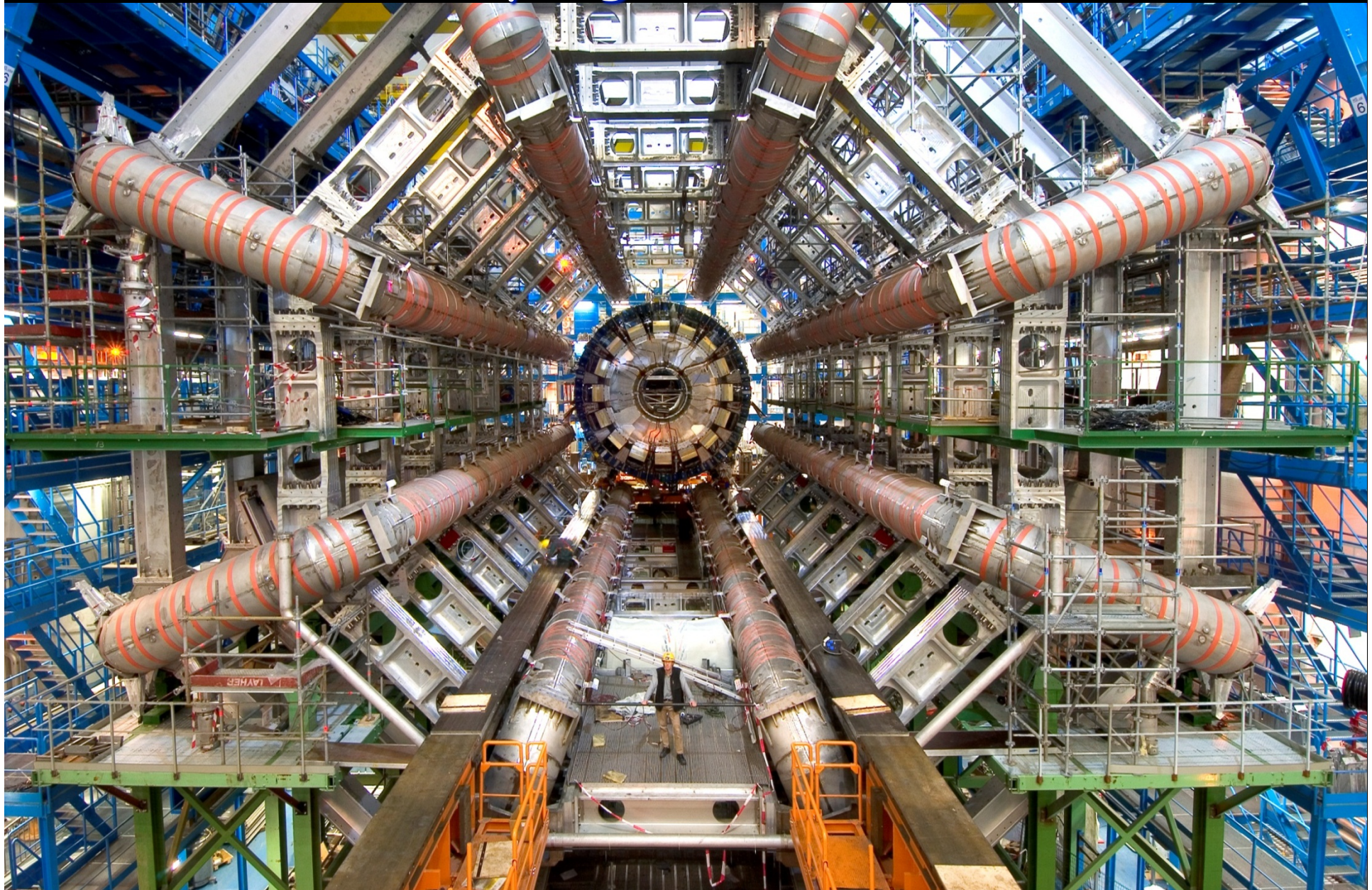

...centrale cilinder...



UX15 Geneva Mon Sep 18 23:00:01 2006

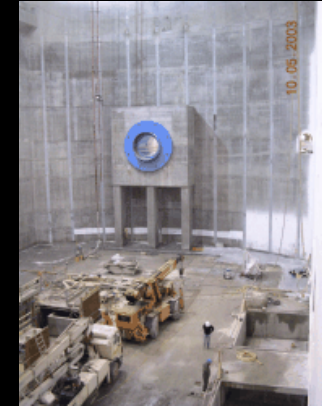
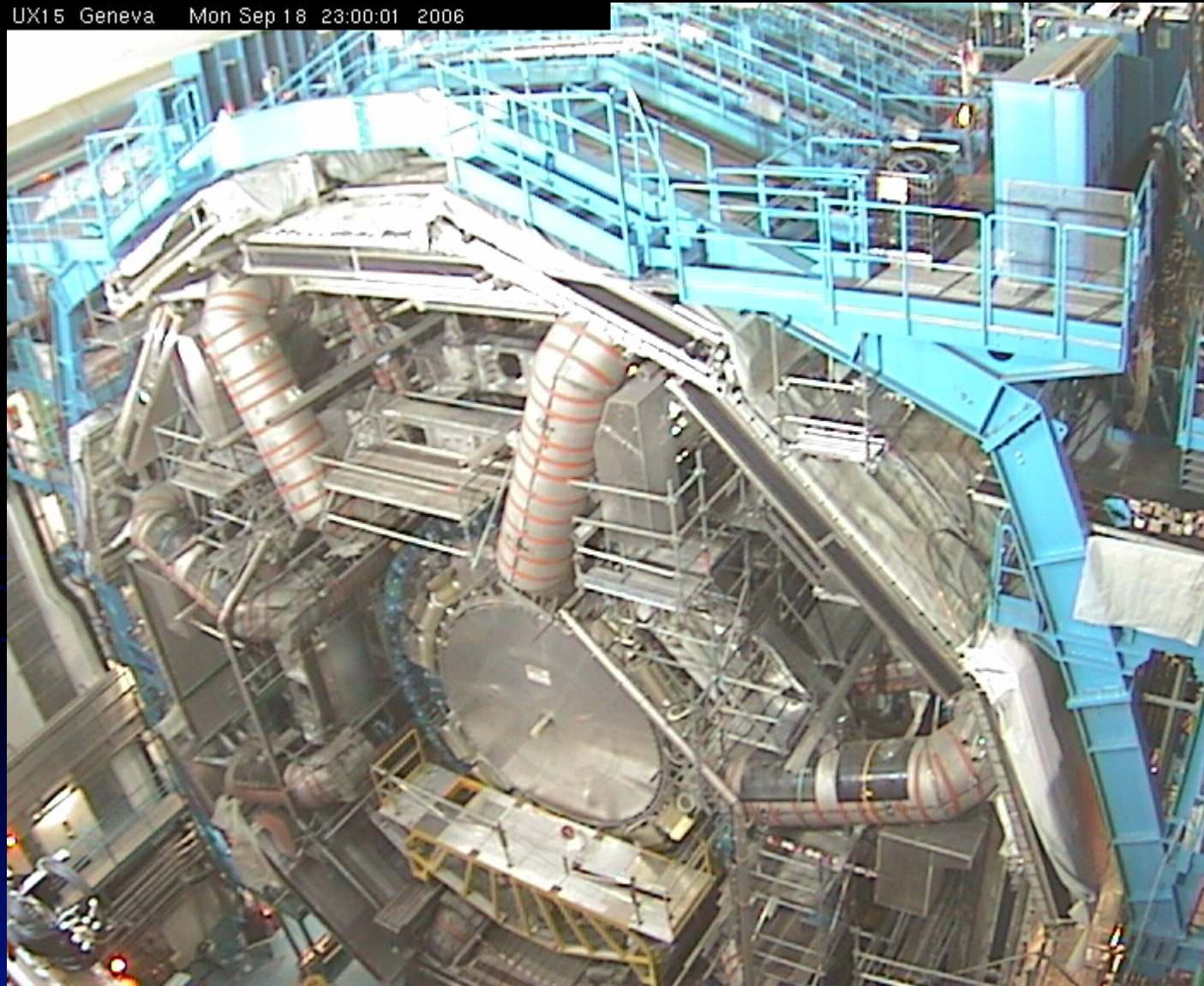

...voorwaartse muon-detectie...

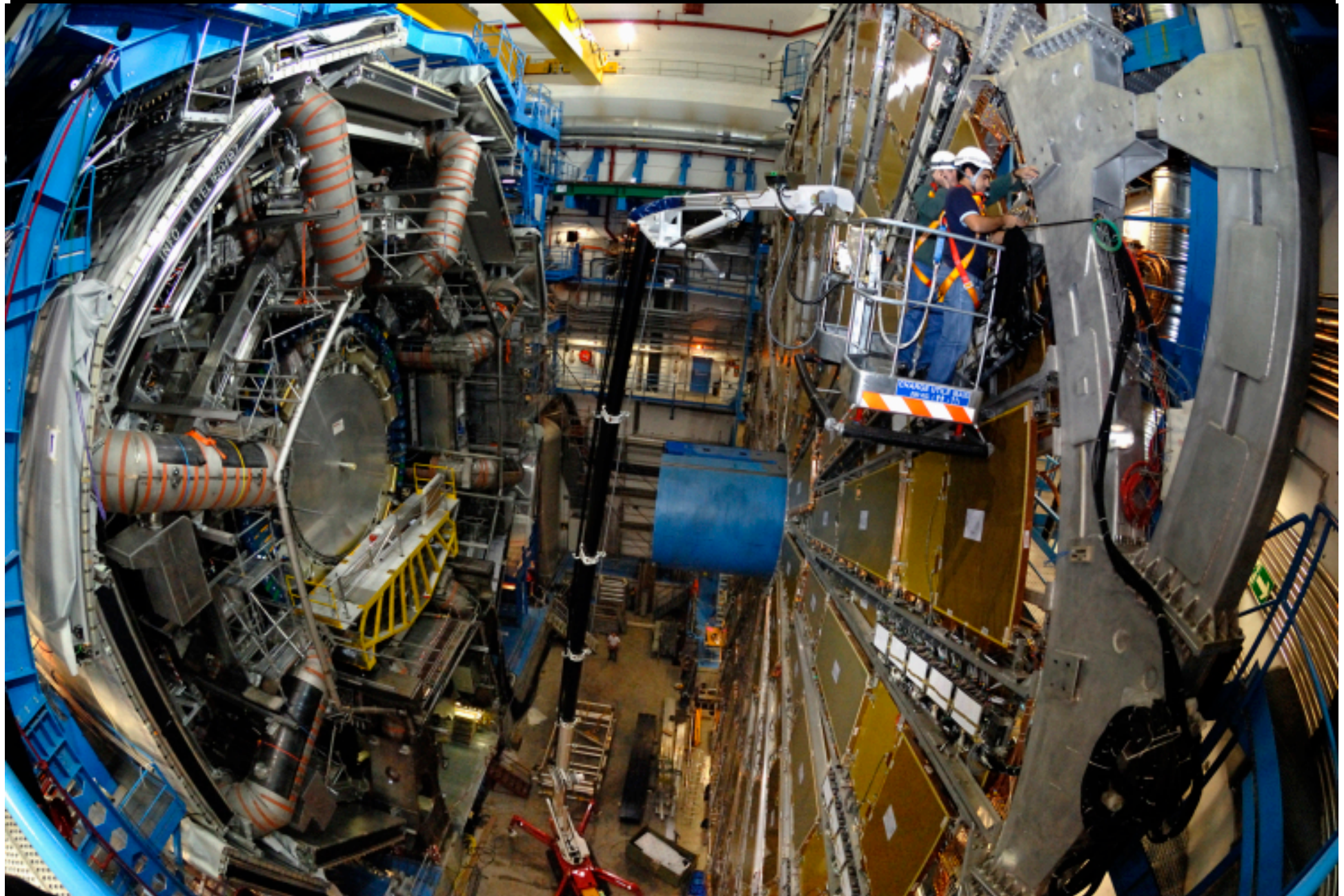

...calorimeter (energie meten)...

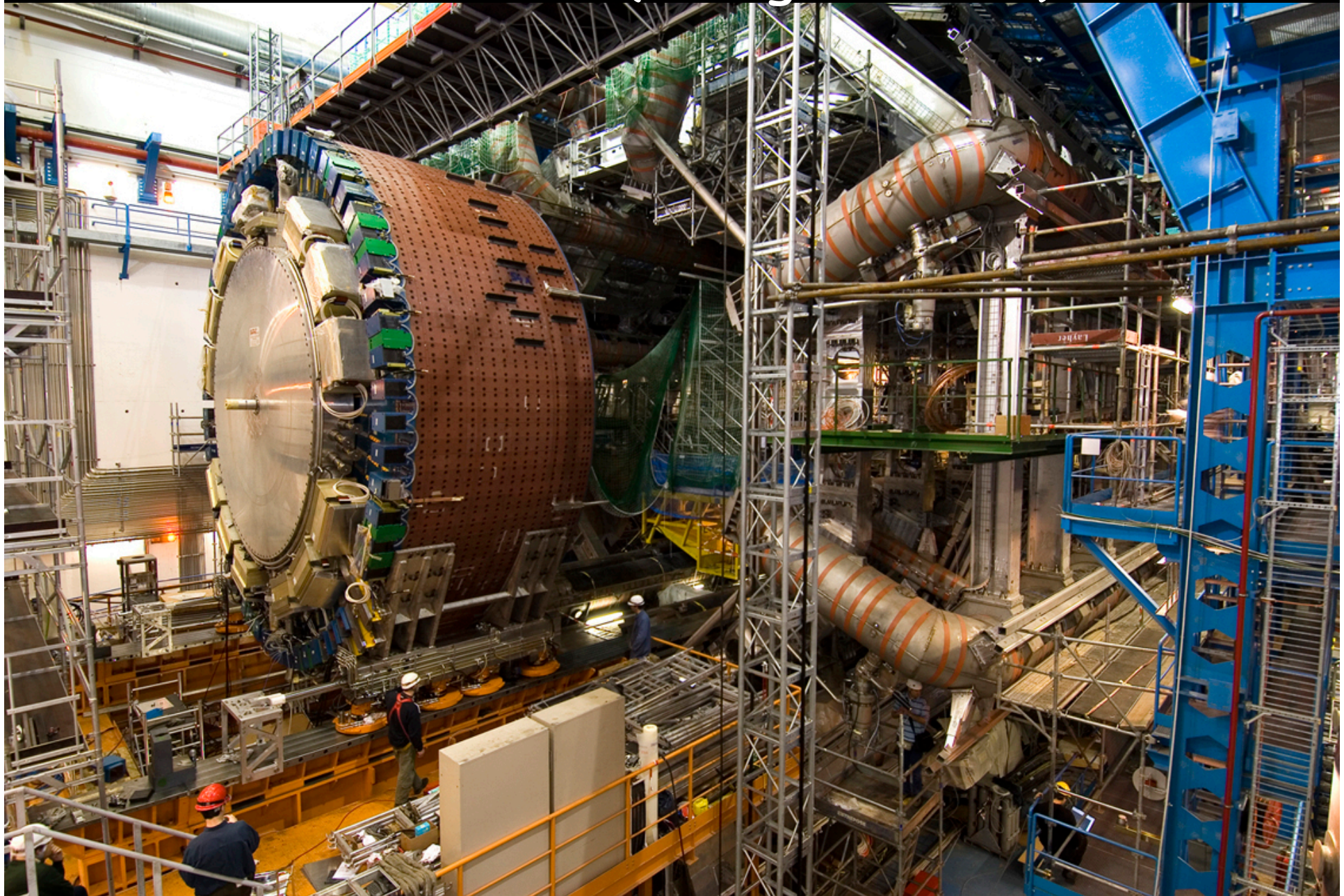

...de
centrale detector...

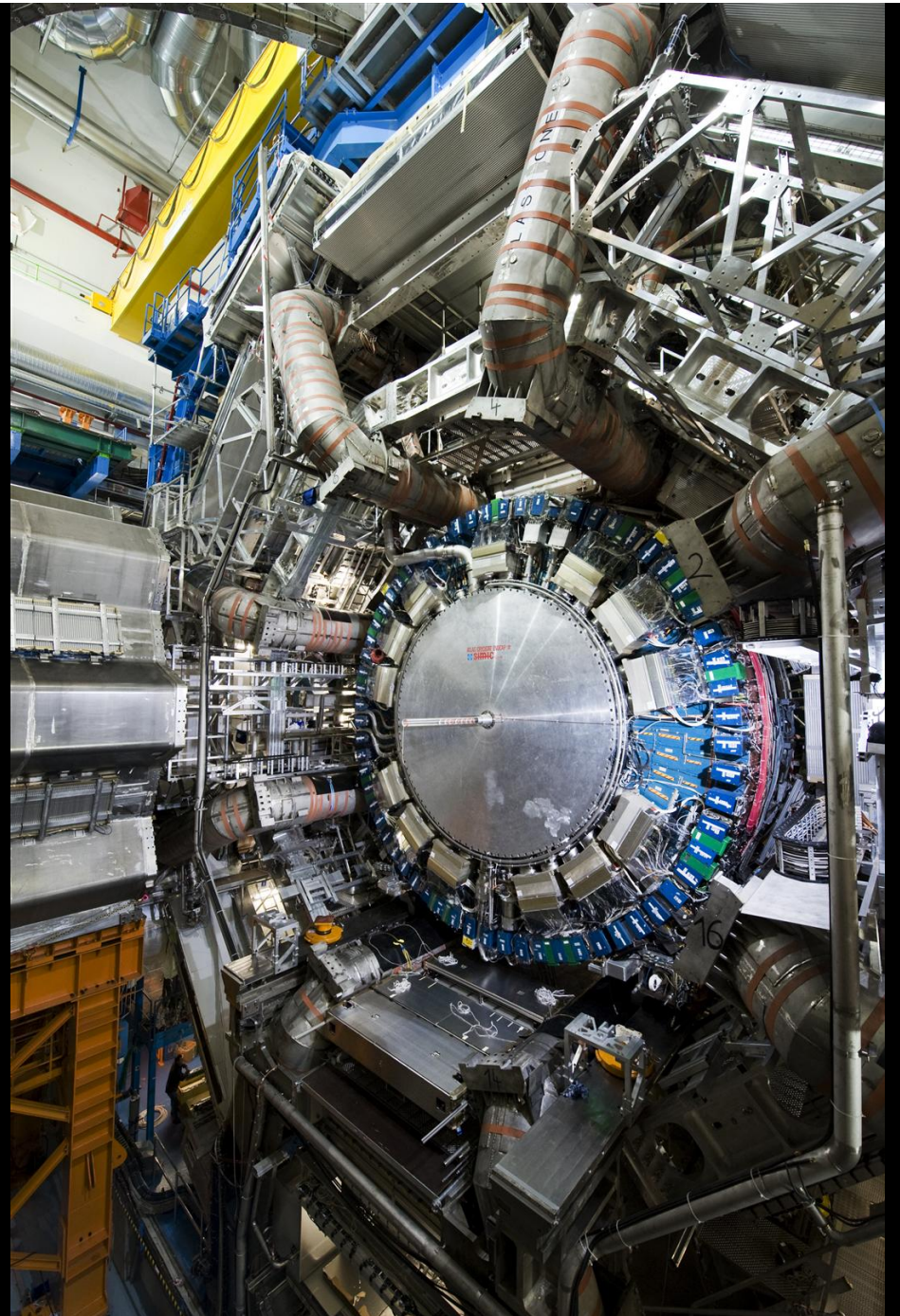
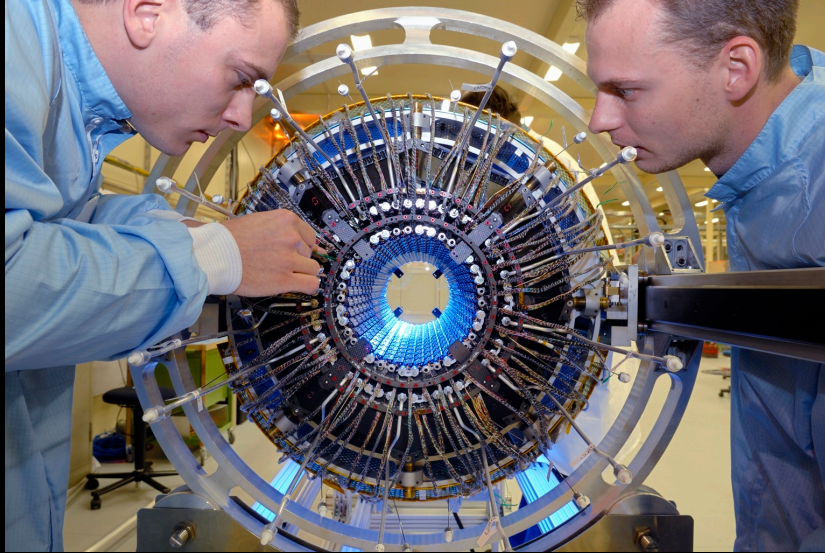

ATLAS "inner detector"

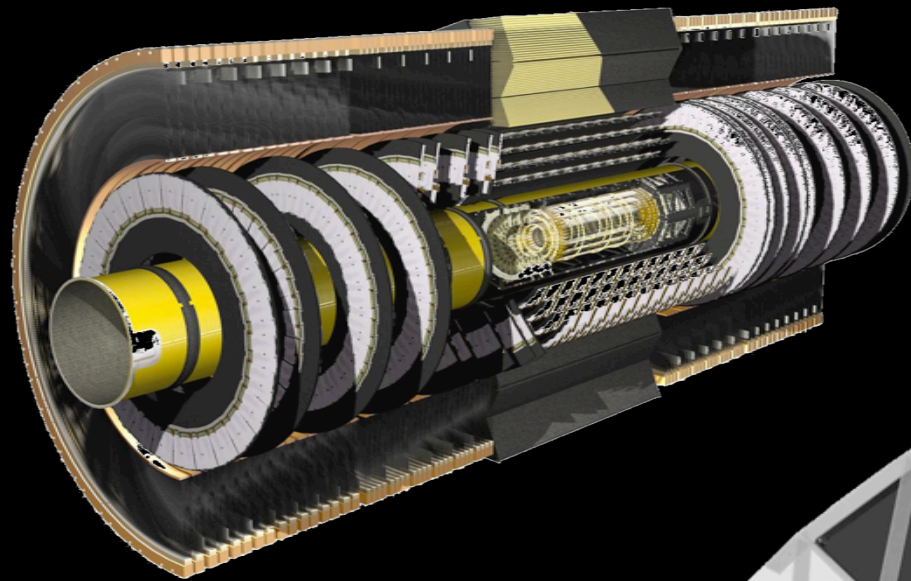

Halfgeleider "tracker"

Transitie straling "tracker"

≥ 30 strootjes
op een spoor

8 lagen silicon strip-
detectoren op een spoor

3 systemen binnen 2 Tesla
solenoidaal magnetisch veld

3 lagen silicon
pixel detectoren
op een spoor

Proton botsingen - iedere 25 ns

Ruwe data wordt "online" geselecteerd (trigger), gereduceerd, opgeslagen, gereconstrueerd en geanalyseerd

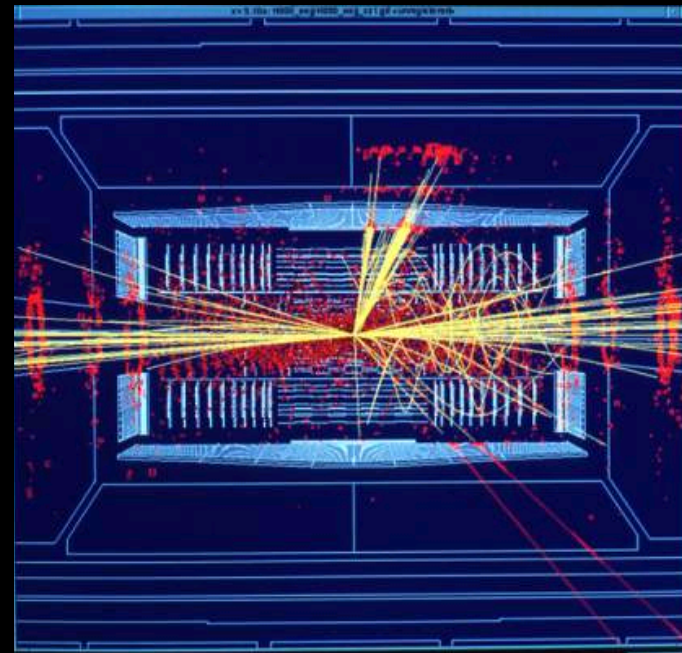
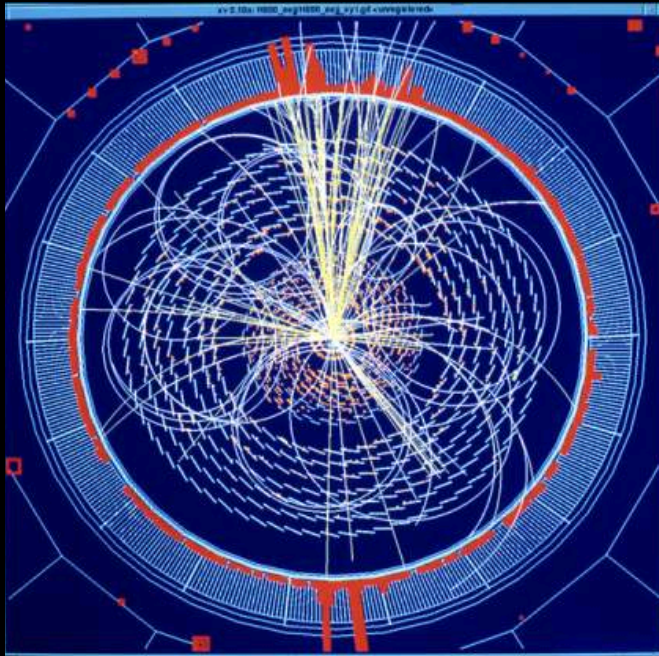

- ~100,000,000 elektronica kanalen
- 600,000,000 proton-proton botsingen per seconde
- Opslag van 100 1 MB events per seconde
- Genereert 10 PB data per jaar.

Deeltjes detecteren in ATLAS...

ATLAS detecteert:

- **Lang-levende** deeltjes:
elektronen
fotonen
protonen
neutronen
muonen
- **Kort-levende** deeltjes
die:
Vervallen in **lang-levende** deeltjes.
- **"Missende"** energie

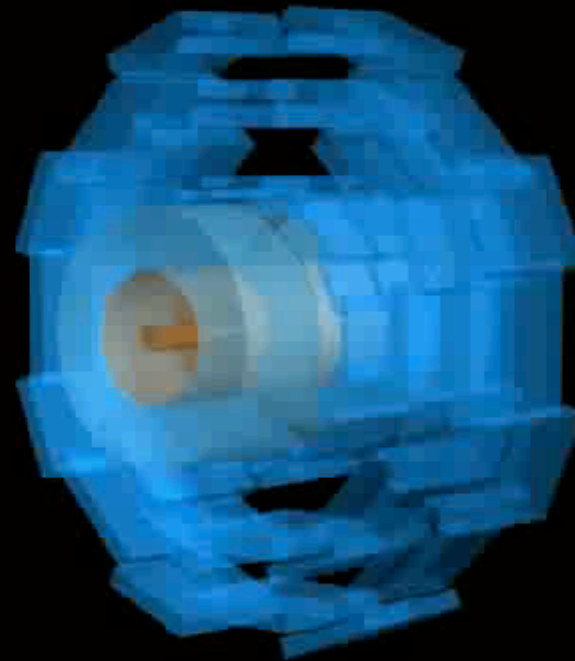

Reconstructie: verval van "langlevende" deeltjes

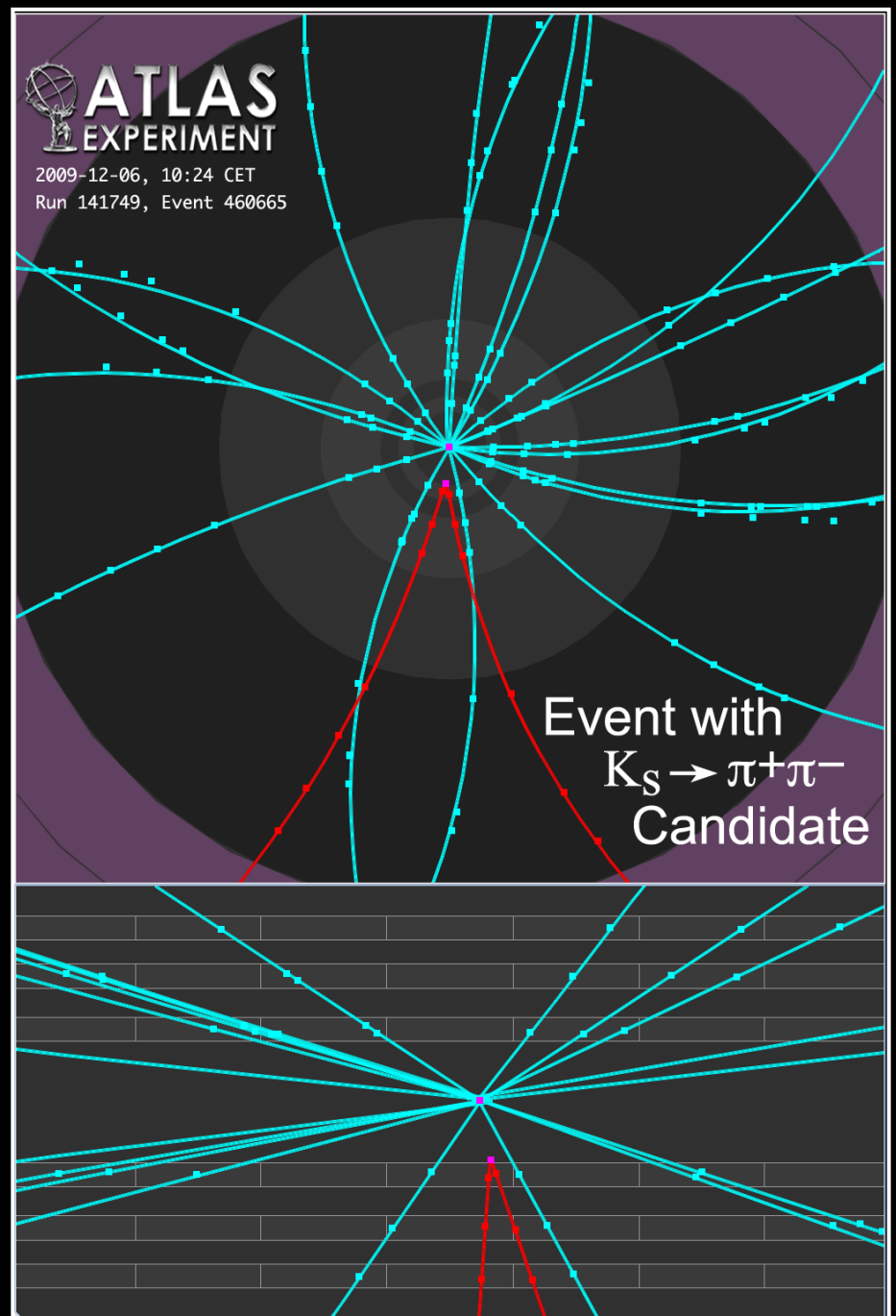
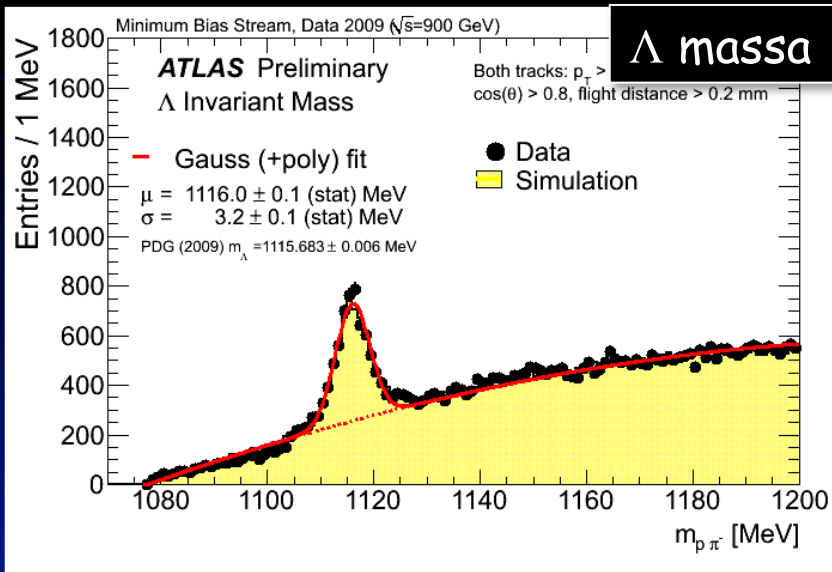
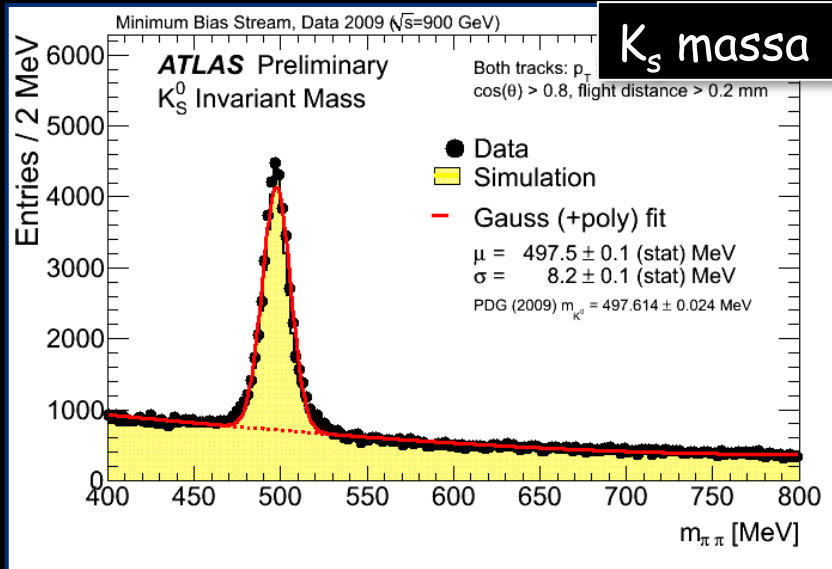

Reconstructie van jets...

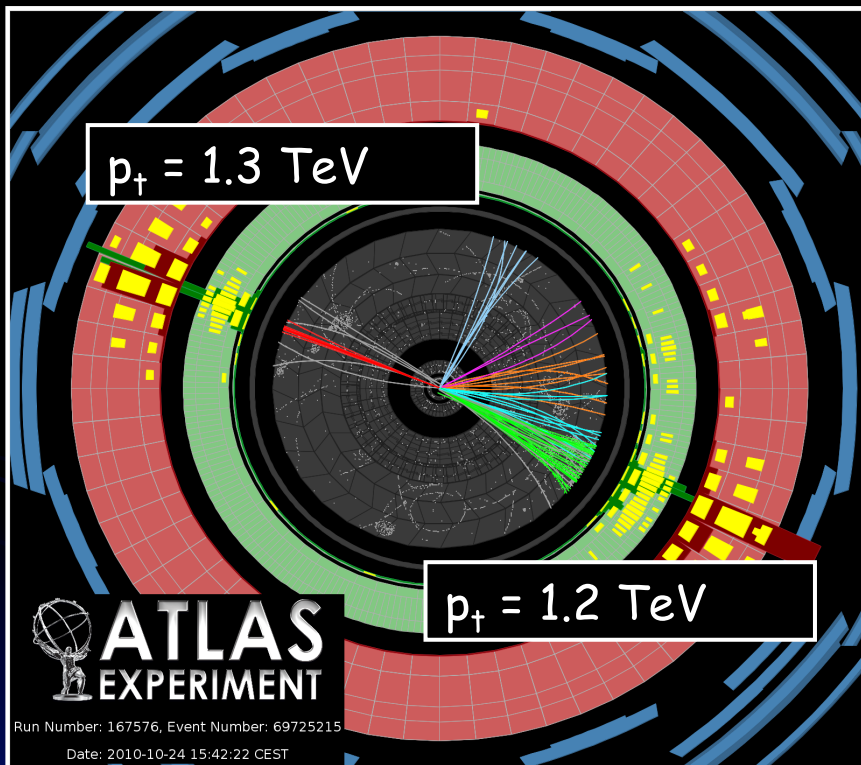

Hoog-energetische jets (2)!

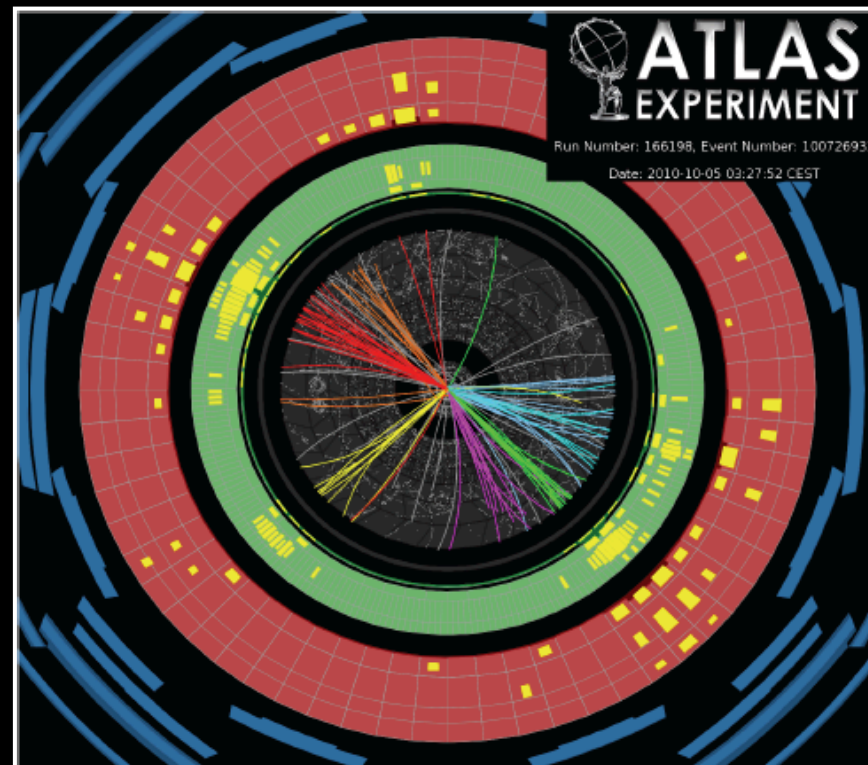

8 (!) jets met $p_{\text{T}} > 60 \text{ GeV}$



ATLAS EXPERIMENT

Run: 154822, Event: 14321500
Date: 2010-05-10 02:07:22 CEST

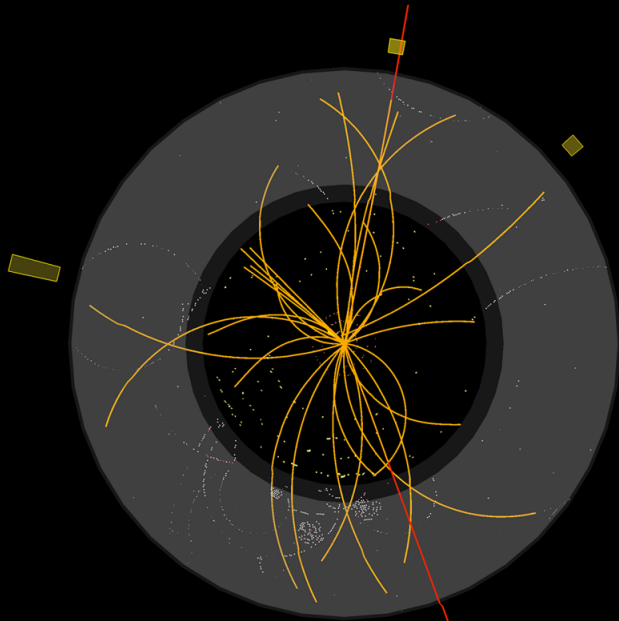

$p_T(\mu^-) = 27 \text{ GeV}$ $\eta(\mu^-) = 0.7$
 $p_T(\mu^+) = 45 \text{ GeV}$ $\eta(\mu^+) = 2.2$
 $M_{\mu\mu} = 87 \text{ GeV}$





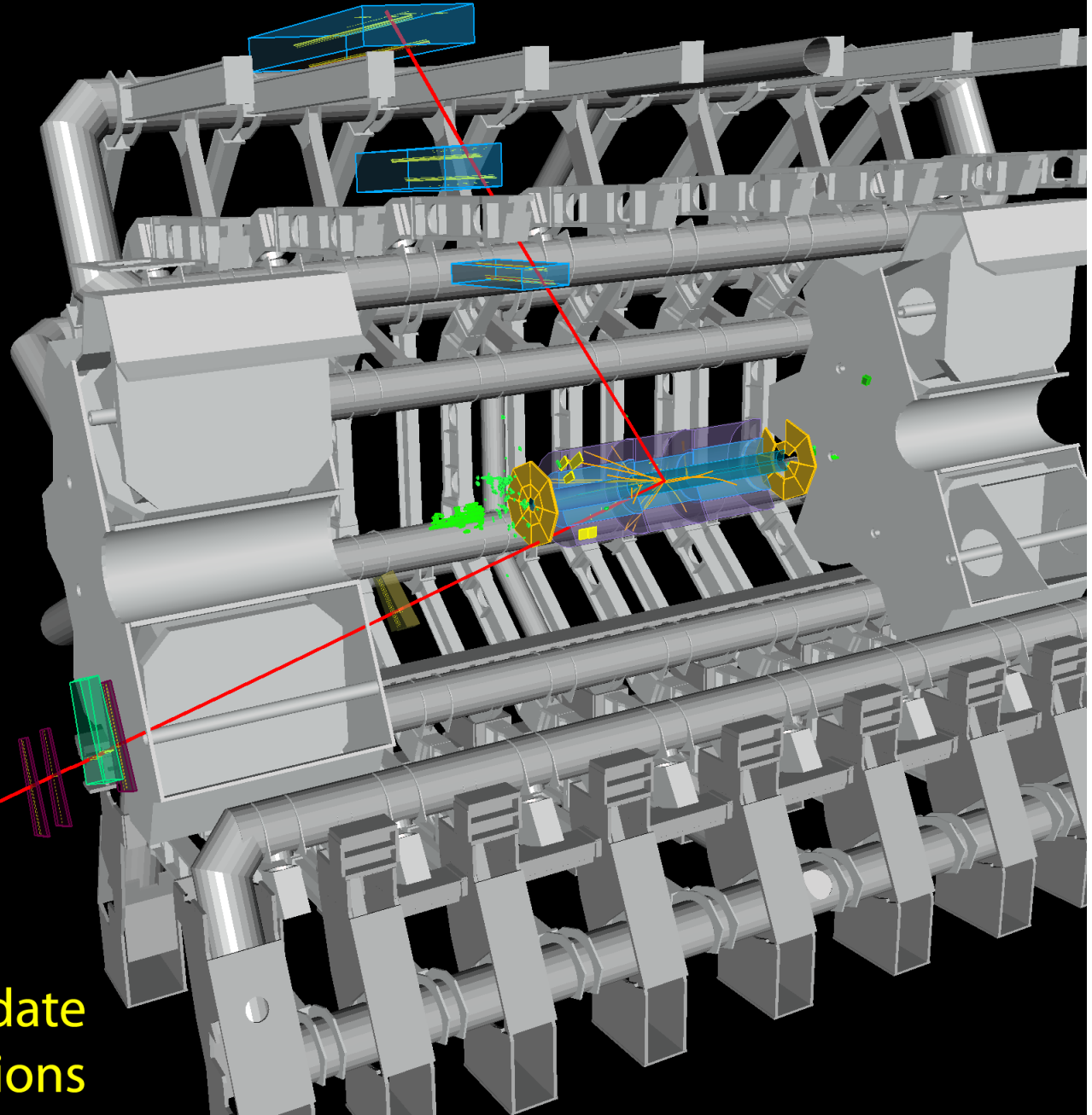



**$Z \rightarrow \mu^+ \mu^-$ candidate
in 7 TeV collisions**



Het "Standaard Model": Elementaire bouwstenen...

6 leptonen:

Electron (e)		-1	Electron neutrino (ν_e)		0
Muon (μ)		-1	Muon neutrino (ν_μ)		0
Tau (τ)		-1	Tau neutrino (ν_τ)		0

6 quarks:

Down (d)		-1/3	Up (u)		+2/3
Strange (s)		-1/3	Charm (c)		+2/3
Bottom (b)		-1/3	Top (t)		+2/3

Kleuren:  R,  B,  G

$$\begin{aligned}
& -\frac{1}{2}\partial_\nu g_\mu^\alpha \partial_\nu g_\mu^\alpha - g_s f^{abc} \partial_\mu g_\nu^a g_\mu^b g_\nu^c - \frac{1}{4}g_s^2 f^{abc} f^{ade} g_\mu^b g_\nu^c g_\mu^d g_\nu^e + \\
& \frac{1}{2}ig_s^2 (\bar{\psi}_i^\mu \gamma^\mu q_j^\nu) g_\mu^\alpha + G^a \partial^2 G^a + g_s f^{abc} \partial_\mu G^a G^b g_\mu^c - \partial_\nu W_\mu^+ \partial_\nu W_\mu^- - \\
& M^2 W_\mu^+ W_\mu^- - \frac{1}{2}\partial_\nu Z_\mu^0 \partial_\nu Z_\mu^0 - \frac{1}{2c_w^2} M^2 Z_\mu^0 Z_\mu^0 - \frac{1}{2}\partial_\mu A_\nu \partial_\mu A_\nu - \frac{1}{2}\partial_\mu H \partial_\mu H - \\
& \frac{1}{2}m_h^2 H^2 - \partial_\mu \phi^+ \partial_\mu \phi^- - M^2 \phi^+ \phi^- - \frac{1}{2}\partial_\mu \phi^0 \partial_\mu \phi^0 - \frac{1}{2c_w} M \phi^0 \phi^0 - \beta_h [\frac{2M^2}{g^2} + \\
& \frac{2M}{g} H + \frac{1}{2}(H^2 + \phi^0 \phi^0 + 2\phi^+ \phi^-)] + \frac{2M^4}{g^2} \alpha_h - ig_{c_w} [\partial_\nu Z_\mu^0 (W_\mu^+ W_\nu^- - \\
& W_\nu^+ W_\mu^-) - Z_\nu^0 (W_\mu^+ \partial_\nu W_\mu^- - W_\mu^- \partial_\nu W_\mu^+) + Z_\mu^0 (W_\nu^+ \partial_\nu W_\mu^- - \\
& W_\nu^- \partial_\nu W_\mu^+)] - ig_{s_w} [\partial_\nu A_\mu (W_\mu^+ W_\nu^- - W_\nu^+ W_\mu^-) - A_\nu (W_\mu^+ \partial_\nu W_\mu^- - \\
& W_\nu^- \partial_\nu W_\mu^+) + A_\mu (W_\nu^+ \partial_\nu W_\mu^- - W_\nu^- \partial_\nu W_\mu^+)] - \frac{1}{2}g^2 W_\mu^+ W_\nu^- W_\nu^+ W_\mu^- + \\
& \frac{1}{2}g^2 W_\mu^+ W_\nu^- W_\mu^+ W_\nu^- + g^2 c_w^2 (Z_\mu^0 W_\nu^+ Z_\nu^0 W_\mu^- - Z_\mu^0 Z_\nu^0 W_\nu^+ W_\mu^-) + \\
& g^2 s_w^2 (A_\mu W_\nu^+ A_\nu W_\mu^- - A_\mu A_\nu W_\nu^+ W_\mu^-) + g^2 s_w c_w [A_\mu Z_\nu^0 (W_\mu^+ W_\nu^- - \\
& W_\nu^+ W_\mu^-) - 2A_\mu Z_\mu^0 W_\nu^+ W_\nu^-] - g\alpha [H^3 + H\phi^0 \phi^0 + 2H\phi^+ \phi^-] - \\
& \frac{1}{8}g^2 \alpha_h [H^4 + (\phi^0)^4 + 4(\phi^+ \phi^-)^2 + 4(\phi^0)^2 \phi^+ \phi^- + 4H^2 \phi^+ \phi^- + 2(\phi^0)^2 H^2] - \\
& gM W_\mu^+ W_\mu^- H - \frac{1}{2}g \frac{M}{c_w} Z_\mu^0 Z_\mu^0 H - \frac{1}{2}ig [W_\mu^+ (\phi^0 \partial_\mu \phi^- - \phi^- \partial_\mu \phi^0) - \\
& W_\mu^- (\phi^0 \partial_\mu \phi^+ - \phi^+ \partial_\mu \phi^0)] + \frac{1}{2}g [W_\mu^+ (H \partial_\mu \phi^- - \phi^- \partial_\mu H) - W_\mu^- (H \partial_\mu \phi^+ - \\
& \phi^+ \partial_\mu H)] + \frac{1}{2}g \frac{1}{c_w} (Z_\mu^0 (H \partial_\mu \phi^0 - \phi^0 \partial_\mu H) - ig \frac{s_w^2}{c_w} M Z_\mu^0 (W_\mu^+ \phi^- - W_\mu^- \phi^+) + \\
& ig_{s_w} M A_\mu (W_\mu^+ \phi^- - W_\mu^- \phi^+) - ig \frac{1-2c_w^2}{2c_w} Z_\mu^0 (\phi^+ \partial_\mu \phi^- - \phi^- \partial_\mu \phi^+) + \\
& ig_{s_w} A_\mu (\phi^+ \partial_\mu \phi^- - \phi^- \partial_\mu \phi^+) - \frac{1}{4}g^2 W_\mu^+ W_\mu^- [H^2 + (\phi^0)^2 + 2\phi^+ \phi^-] - \\
& \frac{1}{4}g^2 \frac{1}{c_w^2} Z_\mu^0 Z_\mu^0 [H^2 + (\phi^0)^2 + 2(2s_w^2 - 1)^2 \phi^+ \phi^-] - \frac{1}{2}g^2 \frac{s_w^2}{c_w} Z_\mu^0 \phi^0 (W_\mu^+ \phi^- + \\
& W_\mu^- \phi^+) - \frac{1}{2}ig^2 \frac{s_w^2}{c_w} Z_\mu^0 H (W_\mu^+ \phi^- - W_\mu^- \phi^+) + \frac{1}{2}g^2 s_w A_\mu \phi^0 (W_\mu^+ \phi^- + \\
& W_\mu^- \phi^+) + \frac{1}{2}ig^2 s_w A_\mu H (W_\mu^+ \phi^- - W_\mu^- \phi^+) - g^2 \frac{s_w}{c_w} (2c_w^2 - 1) Z_\mu^0 A_\mu \phi^+ \phi^- - \\
& g^1 s_w^2 A_\mu A_\mu \phi^+ \phi^- - \bar{e}^\lambda (\gamma \partial + m_e^\lambda) e^\lambda - \bar{\nu}^\lambda \gamma \partial \nu^\lambda - \bar{u}_j^\lambda (\gamma \partial + m_u^\lambda) u_j^\lambda - \bar{d}_j^\lambda (\gamma \partial + \\
& m_d^\lambda) d_j^\lambda + ig_{s_w} A_\mu [-(\bar{e}^\lambda \gamma e^\lambda) + \frac{2}{3}(\bar{u}_j^\lambda \gamma u_j^\lambda) - \frac{1}{3}(\bar{d}_j^\lambda \gamma d_j^\lambda)] + \frac{ig}{4c_w} Z_\mu^0 [(\bar{\nu}^\lambda \gamma^\mu (1 + \\
& \gamma^5) \nu^\lambda) + (\bar{e}^\lambda \gamma^\mu (4s_w^2 - 1 - \gamma^5) e^\lambda) + (\bar{u}_j^\lambda \gamma^\mu (\frac{4}{3}s_w^2 - 1 - \gamma^5) u_j^\lambda) + \\
& (\bar{d}_j^\lambda \gamma^\mu (1 - \frac{8}{3}s_w^2 - \gamma^5) d_j^\lambda)] + \frac{ig}{2\sqrt{2}} W_\mu^+ [(\bar{\nu}^\lambda \gamma^\mu (1 + \gamma^5) e^\lambda) + (\bar{u}_j^\lambda \gamma^\mu (1 + \\
& \gamma^5) C_{\lambda\kappa} d_j^\kappa)] + \frac{ig}{2\sqrt{2}} W_\mu^- [(\bar{e}^\lambda \gamma^\mu (1 + \gamma^5) \nu^\lambda) + (\bar{d}_j^\kappa C_{\lambda\kappa}^\dagger \gamma^\mu (1 + \gamma^5) u_j^\lambda)] + \\
& \frac{ig}{2\sqrt{2}} \frac{m_\lambda^2}{M} [-\phi^+ (\bar{\nu}^\lambda (1 - \gamma^5) e^\lambda) + \phi^- (\bar{e}^\lambda (1 + \gamma^5) \nu^\lambda)] - \frac{g}{2} \frac{m_\lambda^2}{M} [H (\bar{e}^\lambda e^\lambda) + \\
& i\phi^0 (\bar{e}^\lambda \gamma^5 e^\lambda)] + \frac{ig}{2M\sqrt{2}} \phi^+ [-m_d^\lambda (\bar{u}_j^\lambda C_{\lambda\kappa} (1 - \gamma^5) d_j^\kappa) + m_u^\lambda (\bar{u}_j^\lambda C_{\lambda\kappa} (1 + \\
& \gamma^5) d_j^\kappa) + \frac{ig}{2M\sqrt{2}} \phi^- [m_d^\lambda (\bar{d}_j^\kappa C_{\lambda\kappa}^\dagger (1 + \gamma^5) u_j^\kappa) - m_u^\lambda (\bar{d}_j^\kappa C_{\lambda\kappa}^\dagger (1 - \gamma^5) u_j^\kappa) - \\
& \frac{g}{2} \frac{m_\lambda^2}{M} H (\bar{u}_j^\lambda u_j^\lambda) - \frac{g}{2} \frac{m_\lambda^2}{M} H (\bar{d}_j^\lambda d_j^\lambda) + \frac{ig}{2} \frac{m_\lambda^2}{M} \phi^0 (\bar{u}_j^\lambda \gamma^5 u_j^\lambda) - \frac{ig}{2} \frac{m_\lambda^2}{M} \phi^0 (\bar{d}_j^\lambda \gamma^5 d_j^\lambda) + \\
& \bar{X}^+ (\partial^2 - M^2) X^+ + \bar{X}^- (\partial^2 - M^2) X^- + \bar{X}^0 (\partial^2 - \frac{M^2}{c_w^2}) X^0 + \bar{Y} \partial^2 Y + \\
& ig_{c_w} W_\mu^+ (\partial_\mu \bar{X}^0 X^- - \partial_\mu \bar{X}^+ X^0) + ig_{s_w} W_\mu^+ (\partial_\mu \bar{Y} X^- - \partial_\mu \bar{X}^+ Y) + \\
& ig_{c_w} W_\mu^- (\partial_\mu \bar{X}^- X^0 - \partial_\mu \bar{X}^0 X^+) + ig_{s_w} W_\mu^- (\partial_\mu \bar{X}^- Y - \partial_\mu \bar{Y} X^+) + \\
& ig_{c_w} Z_\mu^0 (\partial_\mu \bar{X}^+ X^- - \partial_\mu \bar{X}^- X^+) + ig_{s_w} A_\mu (\partial_\mu \bar{X}^+ X^- - \partial_\mu \bar{X}^- X^+) - \\
& \frac{1}{2}gM [\bar{X}^+ X^+ H + \bar{X}^- X^- H + \frac{1}{c_w} \bar{X}^0 X^0 H] + \frac{1-2c_w^2}{2c_w} igM [\bar{X}^+ X^0 \phi^- - \\
& \bar{X}^- X^0 \phi^-] + \frac{1}{2c_w} igM [\bar{X}^0 X^- \phi^+ - \bar{X}^0 X^+ \phi^-] + igM s_w [\bar{X}^0 X^- \phi^+ - \\
& \bar{X}^0 X^+ \phi^-] + \frac{1}{2}igM [\bar{X}^+ X^+ \phi^0 - \bar{X}^- X^- \phi^0]
\end{aligned}$$

...en hun interacties:

- Elegant mathematisch bouwwerk gebaseerd op:
 - Symmetrie (Emmy Noether)
 - quantummechanica
 - relativiteitstheorie
 - bij toenemende energie "koppelen" verschillende krachten even "sterk"
- Uitgebreide experimentele toetsing
- Echter nog vele vragen o.a.:
 - gravitatie ?
 - massa van deeltjes ?
 - waarom deze symmetrie ?
 - waar is alle anti-materie ?
 - donkere energie ?
 - donkere materie ?
 - ...

Het "Higgs" beeld van massa

- In het "echte" vacuüm zijn **alle** deeltjes massaloos (dus: $v = c$)
- "Ons" vacuüm is niet echt leeg, maar gevuld met het **Higgs veld** (vgl elektromagnetisch veld)
- Deeltjes hebben interactie met **Higgs veld**:
 - hierdoor bewegen ze langzamer
 - ze krijgen op die manier **massa** !
- Het **Higgs veld** impliceert het bestaan van een **Higgs deeltje** (vgl elektromagnetische veld en foton etc.)

Het Higgs (veld): "Nat" licht

- In water, is de snelheid van (zichtbaar) licht ongeveer 30% kleiner dan in "vacuüm"

$$\left(\begin{array}{l} c_0 = \frac{1}{\sqrt{\epsilon_0 \mu_0}} = 299792458 \text{ (m/s)} \\ n = \sqrt{\epsilon_r \mu_r} = 1.3330 @ 20^0C \end{array} \right)$$

- Echter, de energie van het foton (licht) blijft gelijk (de kleur van een rode laser straal verandert niet in water; het blijft rood!)
- Daarom, terwijl de fotonen in het vacuüm massaloos zijn, hebben zij in water een massa verkregen!

(R. Kleiss - Nijmegen)

Wat weten we van het Higgs?

Het Higgs is een scalair deeltje: spin = 0, maar $m_{\text{Higgs}} = ?$
Het Higgs "koppelt" aan een deeltje met een sterkte evenredig met de massa van dat deeltje!

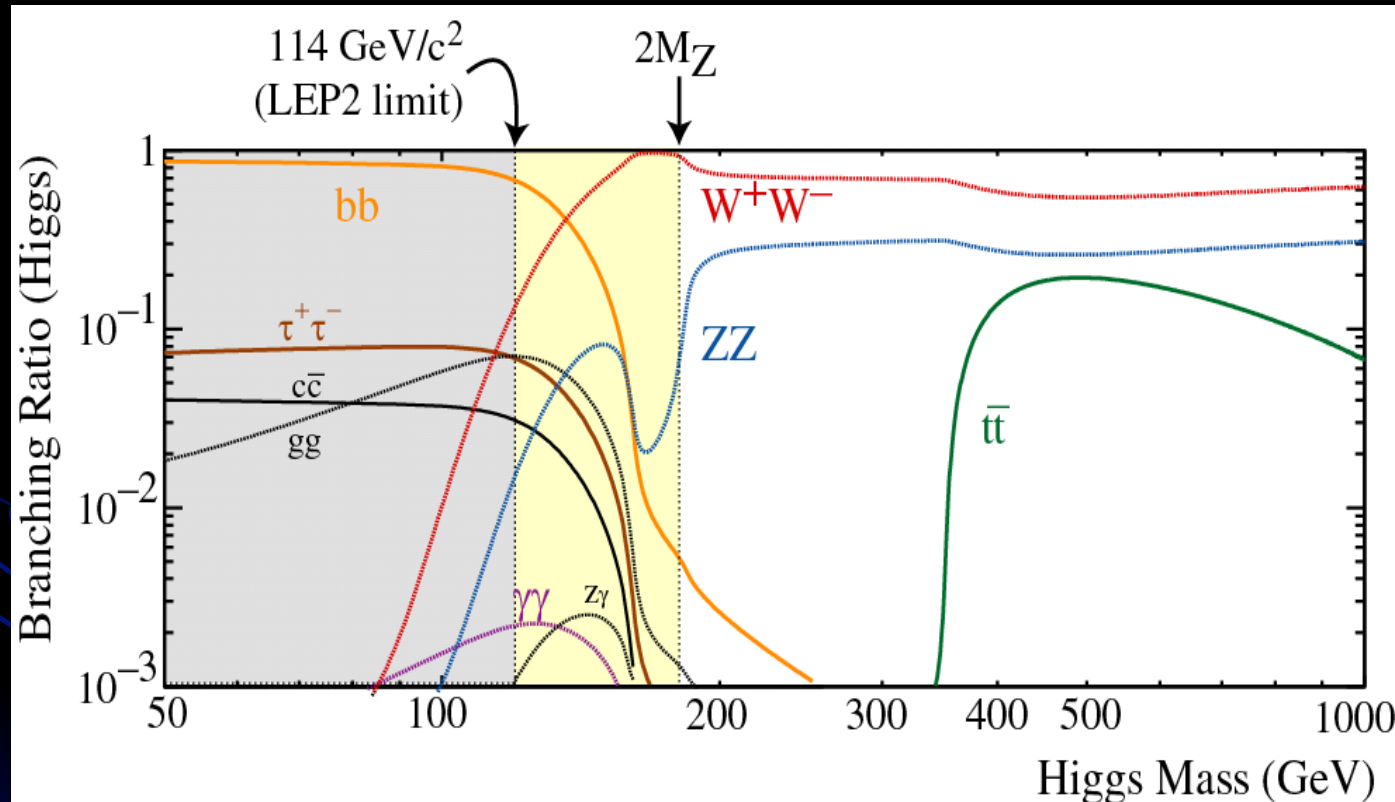

Vervalkans als een functie van de Higgs massa
(voorspeld door het Standaard Model)

Vingerafdruk van het Higgs boson

Voor iedere massa zijn er meerdere kanalen;
- hier volgen de belangrijkste -

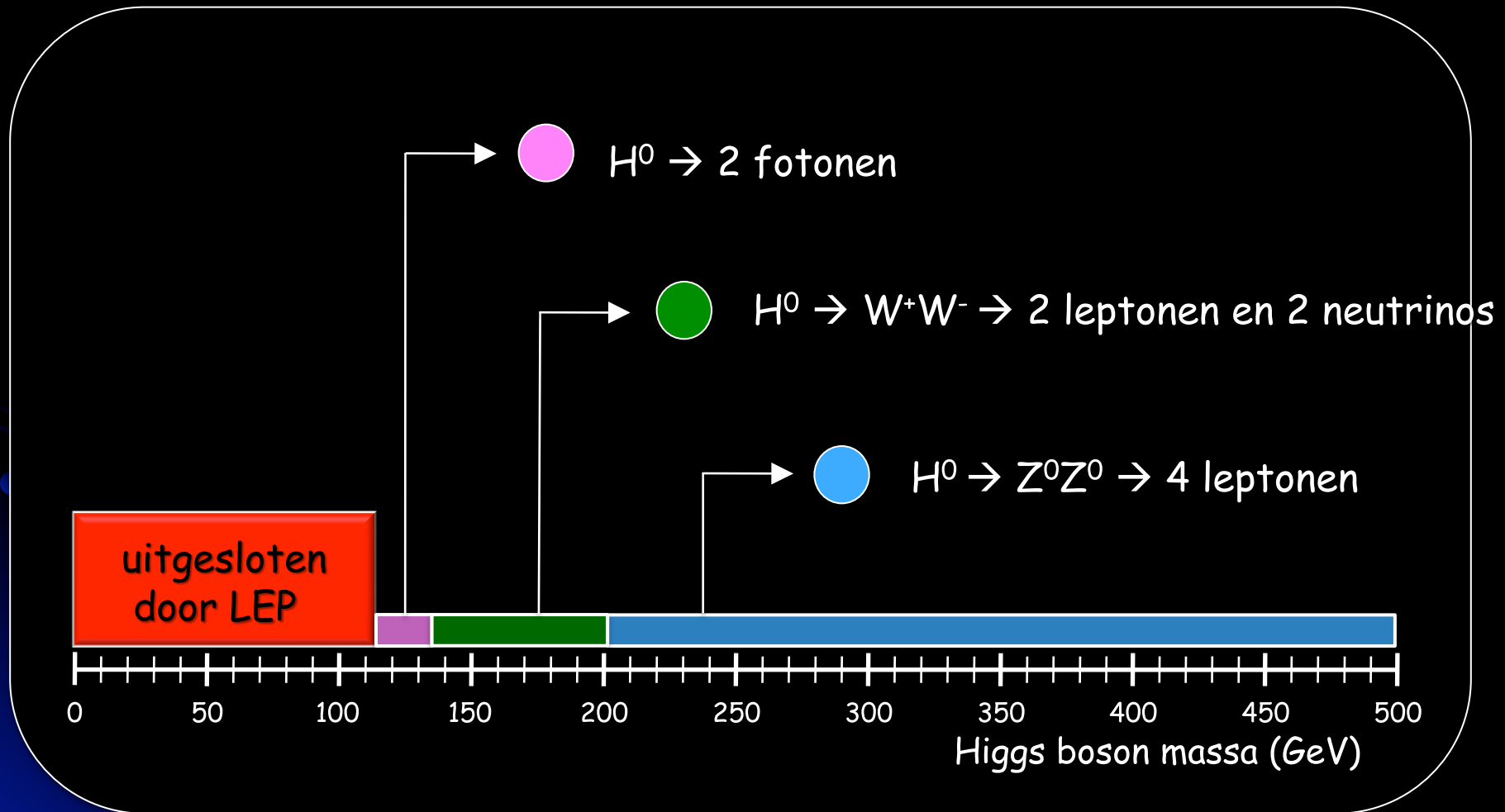

Higgs \rightarrow $Z^0 Z^0 \rightarrow$ 4μ kandidaat

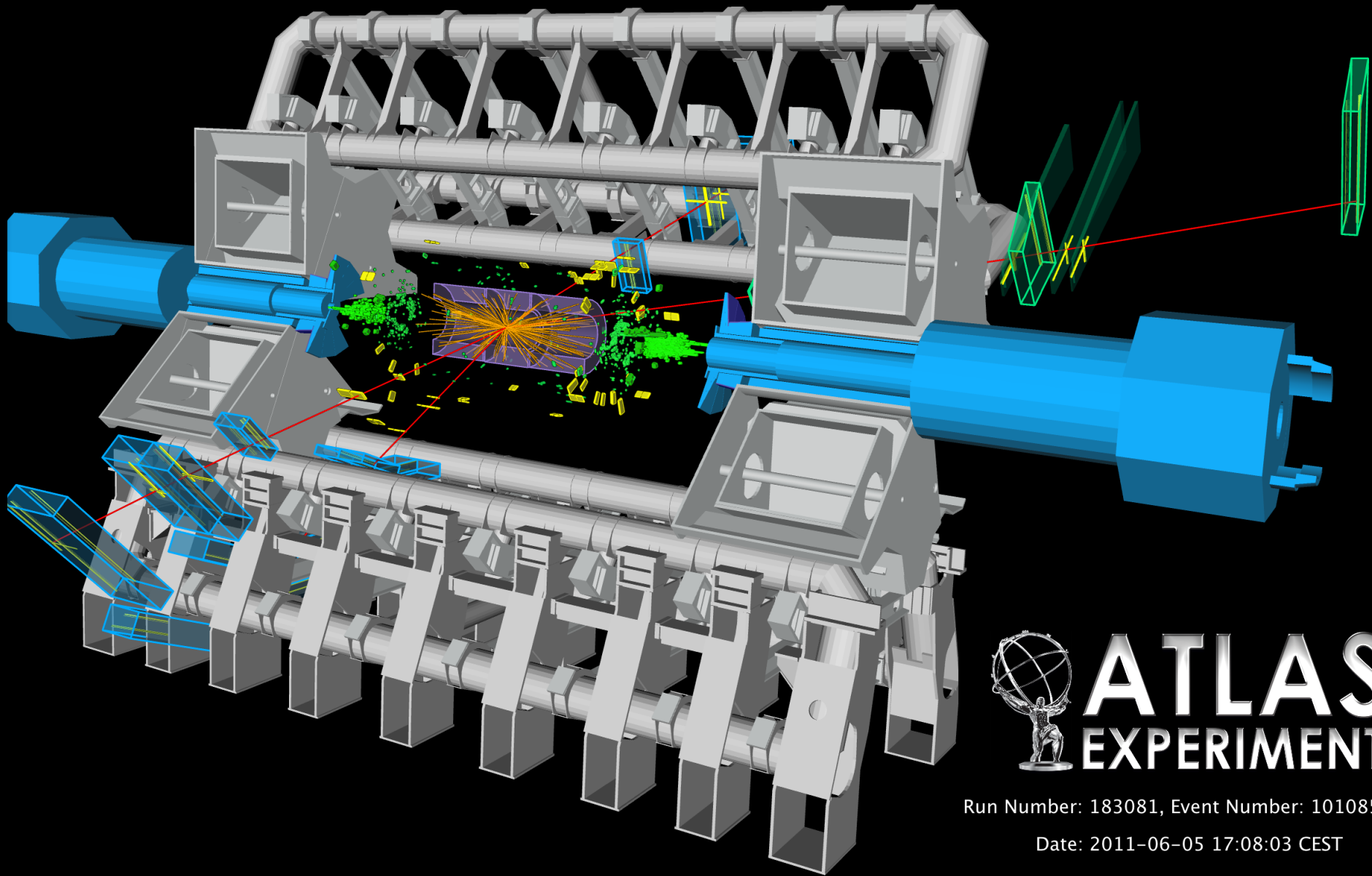

Run Number: 183081, Event Number: 10108572

Date: 2011-06-05 17:08:03 CEST

Higgs \rightarrow $W^+W^- \rightarrow e, \mu, \nu_e, \nu_\mu$ kandidaat

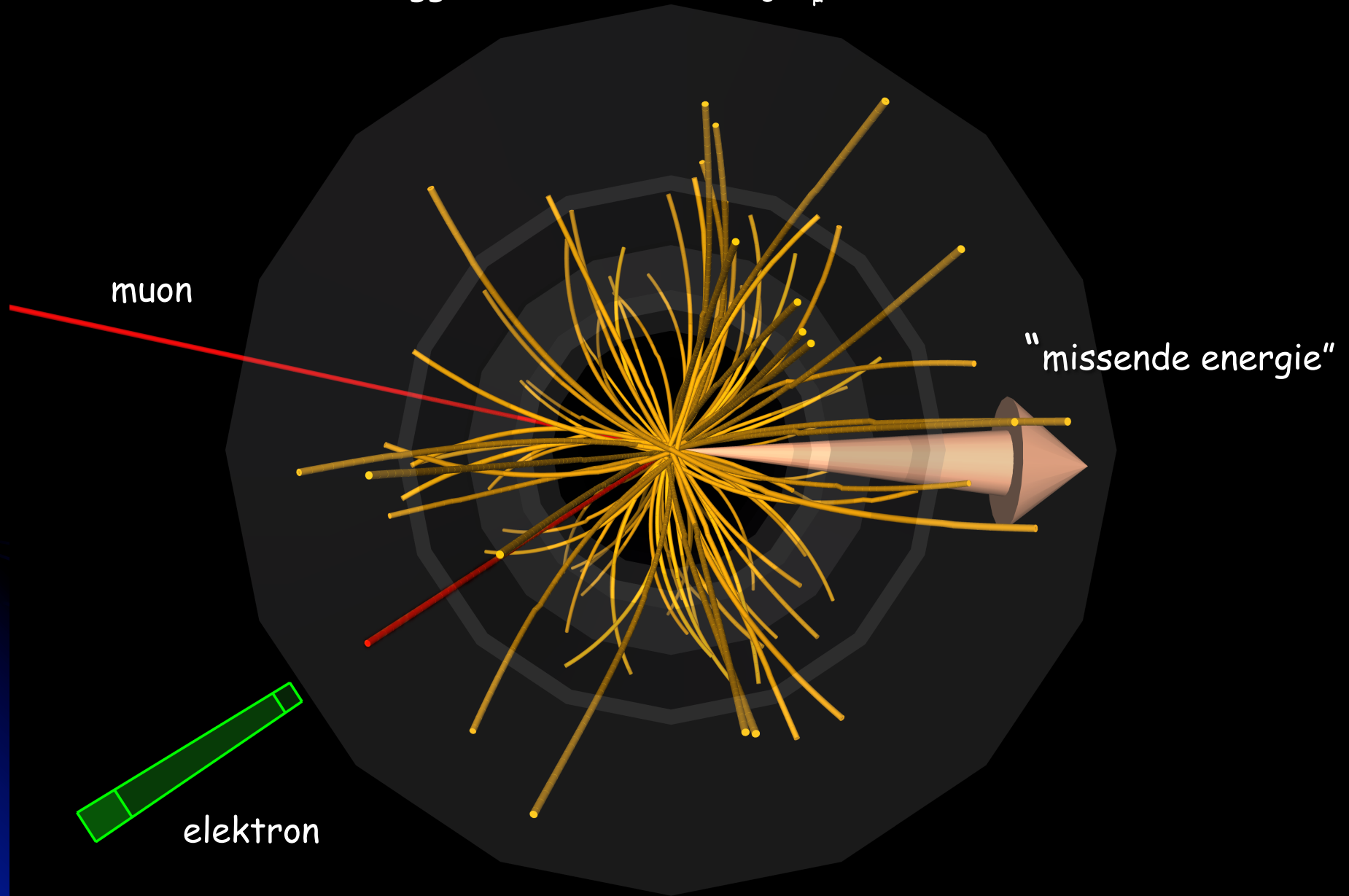

De ATLAS metingen

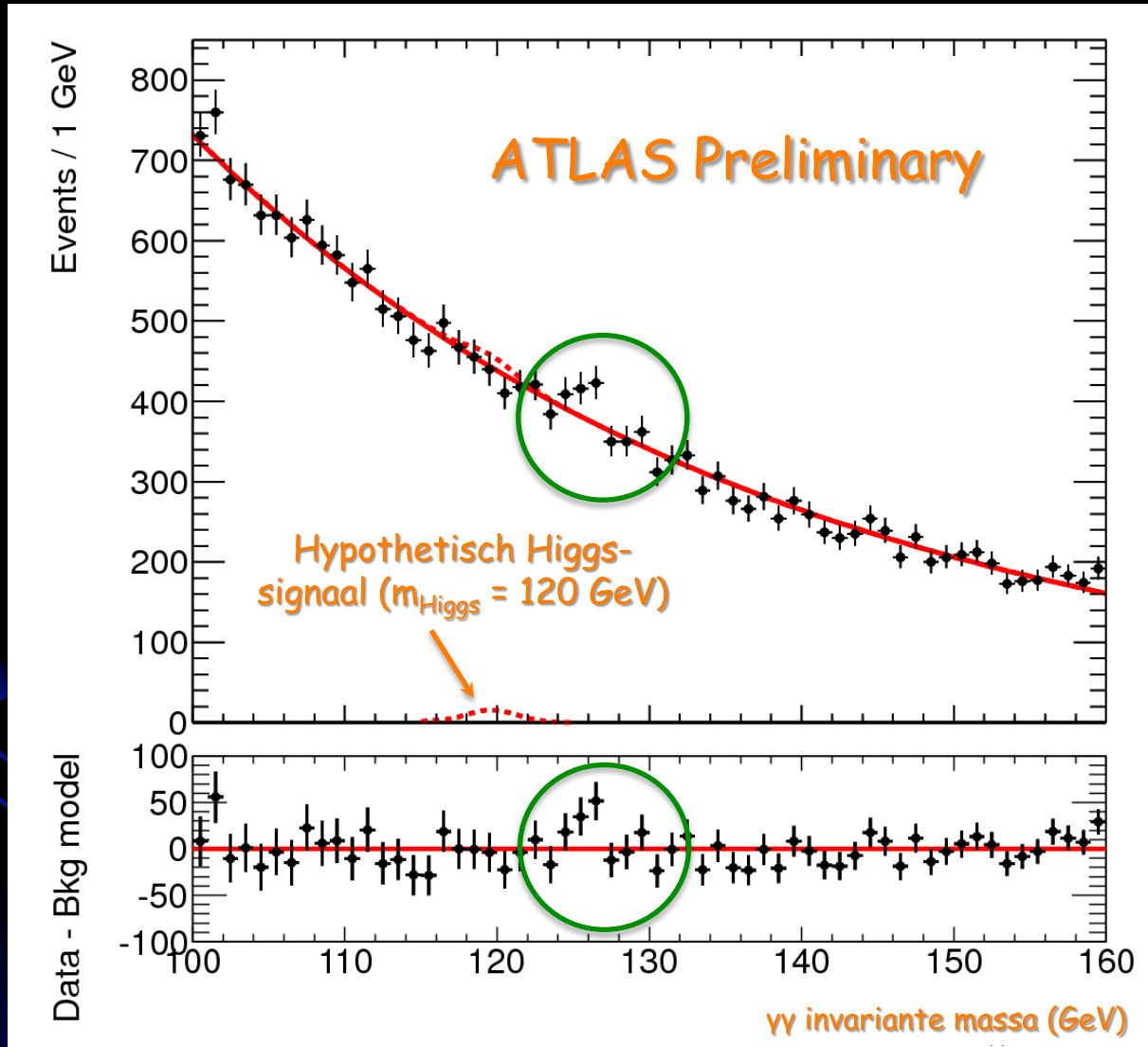

fluctuatie ?

Higgs → 2 fotonen

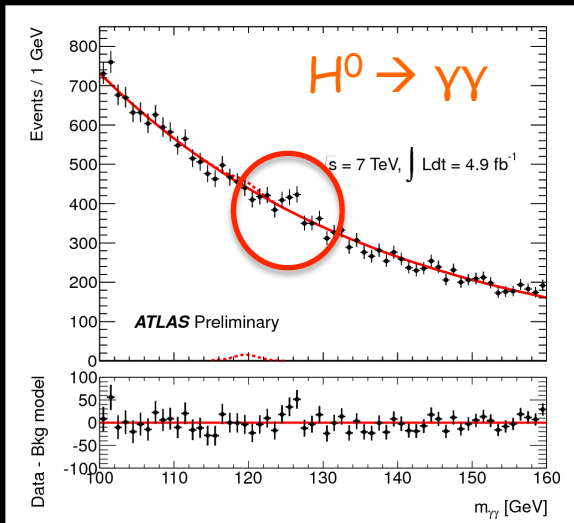

Higgs → 4 leptonen

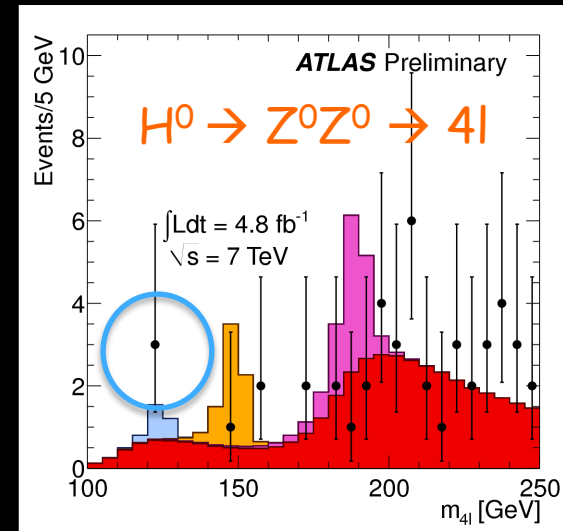

Overschot in twee kanalen zichtbaar

Gecombineerde overschot

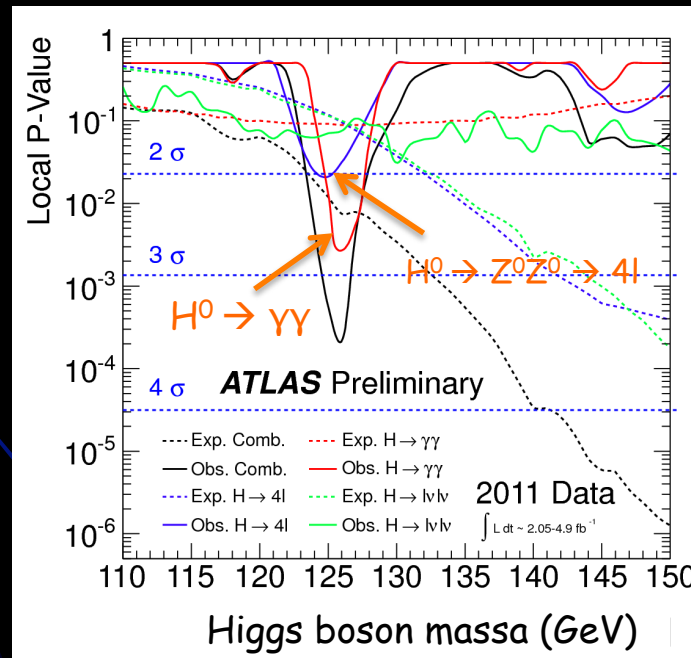

Kans op toevallige fluctuatie

Kans ~ 1/100 (2.3 σ)

Huidige stand van zaken

(versneller afgelopen week weer in bedrijf bij hogere energie - 4 TeV/bundel -)

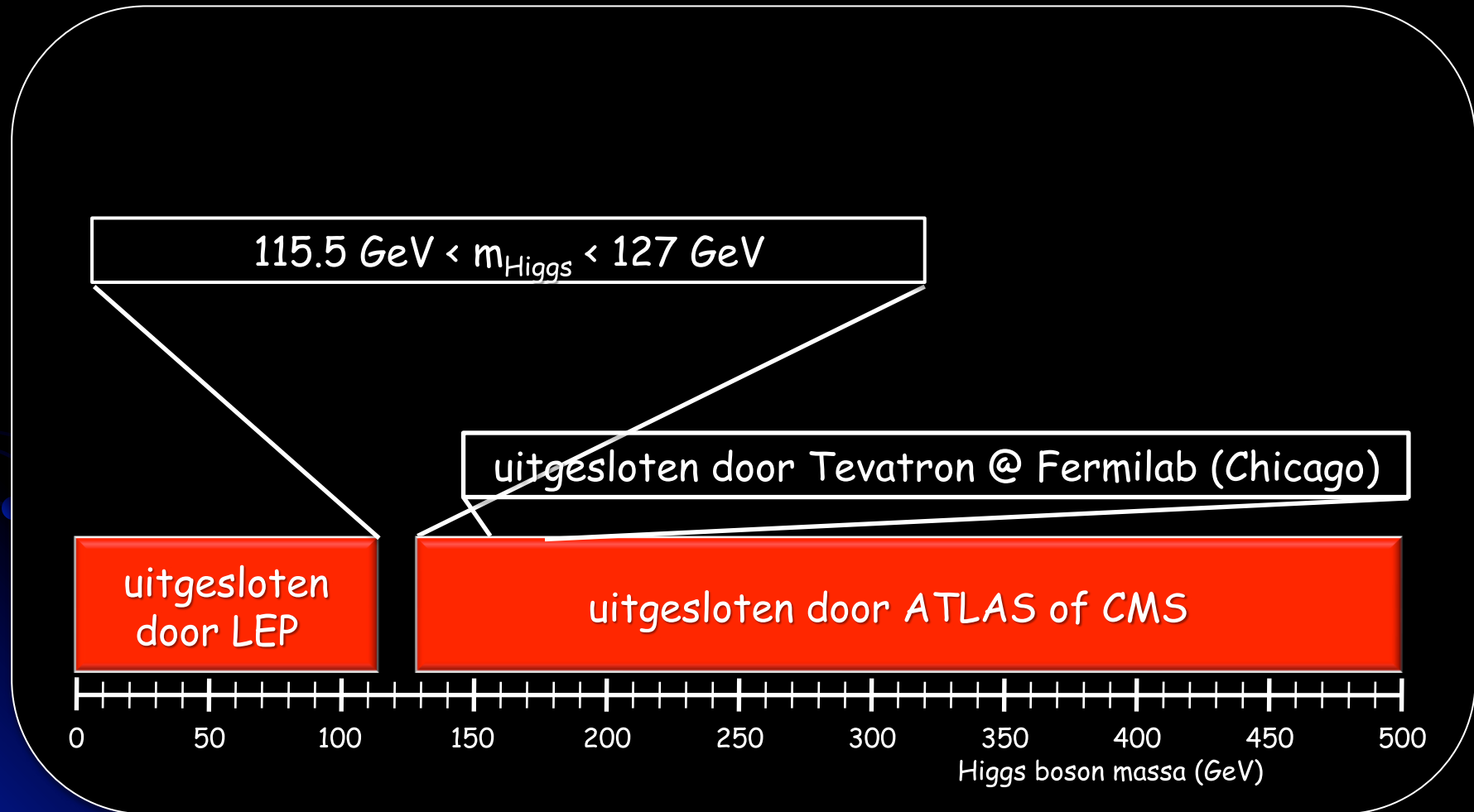

Interpretatie van ATLAS meetgegevens

- Kans op toevallige fluctuatie zoals geobserveerd of nog groter: ~ 1 op 100
- Toeval?
- Ontdekking: kans op een toevallige fluctuatie kleiner dan 1 op 1,000,000 !



- kans 1 dobbelsteen "6 gooien": $1/6$
- kans 2 dobbelstenen op "dubbel 6": $1/6 \times 1/6 = 1/36$
- ...
- kans 8 dobbelstenen allemaal "op 6": ~1 op 1,000,000 !